



HIRSCHMANN

A **BELDEN** BRAND

User Manual

Installation

Modular Industrial Ethernet Backbone Switch

MACH4000 family

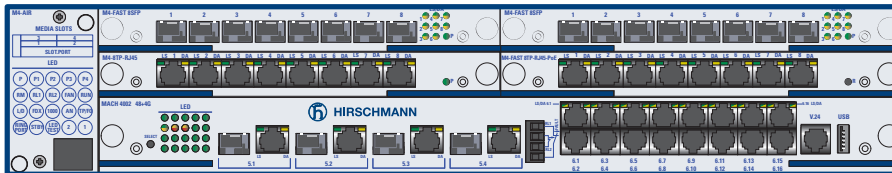

MACH 4002-48+4G

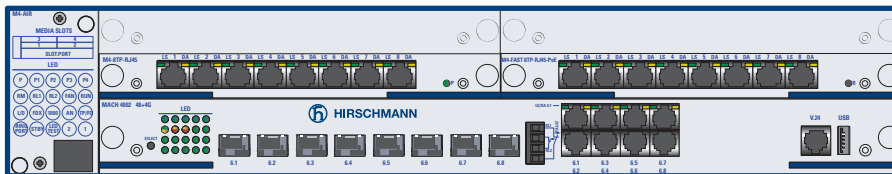

MACH 4002-24G

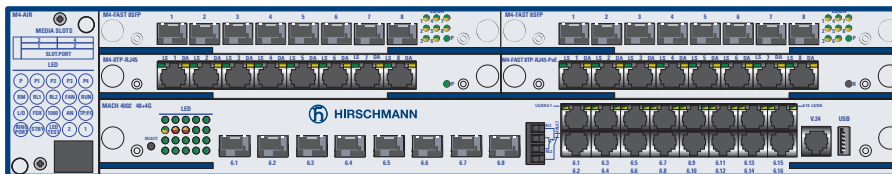

MACH 4002-48G

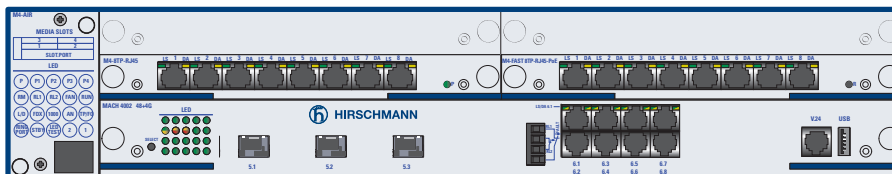

MACH 4002-24G+3X

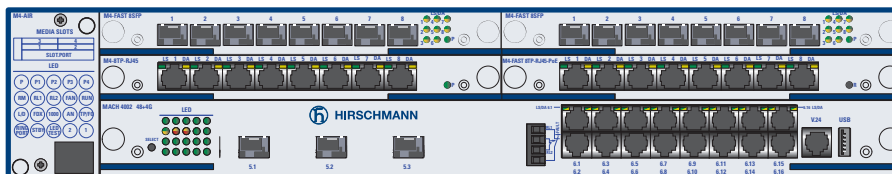

MACH 4002-48G+3X



The naming of copyrighted trademarks in this manual, even when not specially indicated, should not be taken to mean that these names may be considered as free in the sense of the trademark and tradename protection law and hence that they may be freely used by anyone.

© 2013 Hirschmann Automation and Control GmbH

Manuals and software are protected by copyright. All rights reserved. The copying, reproduction, translation, conversion into any electronic medium or machine scannable form is not permitted, either in whole or in part. An exception is the preparation of a backup copy of the software for your own use. For devices with embedded software, the end-user license agreement on the enclosed CD/DVD applies.

The performance features described here are binding only if they have been expressly agreed when the contract was made. This document was produced by Hirschmann Automation and Control GmbH according to the best of the company's knowledge. Hirschmann reserves the right to change the contents of this document without prior notice. Hirschmann can give no guarantee in respect of the correctness or accuracy of the information in this document.

Hirschmann can accept no responsibility for damages, resulting from the use of the network components or the associated operating software. In addition, we refer to the conditions of use specified in the license contract.

You can get the latest version of this manual on the Internet at the Hirschmann product site (www.hirschmann.com).

Printed in Germany
Hirschmann Automation and Control GmbH
Stuttgarter Str. 45-51
72654 Neckartenzlingen
Germany
Tel.: +49 1805 141538

Contents

Safety instructions	5
About this manual	11
Legend	12
1 Description	13
1.1 General device description	13
1.2 MACH4000 Basic Device	14
1.3 Supply voltage	18
1.3.1 Supply voltage on the back of the device	19
1.3.2 M4-POWER power unit chassis	19
1.4 Fan	21
1.4.1 M4-AIR plug-in fan	21
1.4.2 Monitoring temperature and fan	22
1.5 Integrated basic board	23
1.5.1 Left area of basic board	24
1.5.2 Right area of basic board	25
1.6 Signal contact	26
1.7 Media modules	27
1.7.1 M4-8TP-RJ45	27
1.7.2 M4-FAST 8TP-RJ45-PoE	28
1.7.3 M4-FAST 8-SFP	28
1.7.4 M4-GIGA 8-SFP	28
1.8 SFP/XFP transceiver	29
1.9 Ethernet ports	30
1.9.1 10/100/1000 Mbit/s twisted pair connection	30
1.9.2 100 Mbit/s F/O connection	30
1.9.3 1000 Mbit/s F/O connection	31
1.9.4 10 Gbit/s F/O connection	31
1.9.5 PoE ports	31
1.9.6 Combo ports	32
1.10 Display elements	32
1.10.1 Device state	32
1.10.2 Port status display	34
1.10.3 ACA auto configuration adapter	35
2 Installation	39
2.1 Unpacking and checking	39

2.2	Installing the device and grounding	39
2.2.1	Selecting the assembly location	39
2.2.2	Mounting on a flat surface	40
2.2.3	Mounting in a switch cabinet	40
2.2.4	Grounding	42
2.3	Mounting the power supply unit on the back of the MACH4000 device	42
2.4	Mounting the power unit chassis, connecting with the MACH4000 device	43
2.5	Installing the M4-AIR... plug-in fan unit	44
2.6	Installing the plug-in power units in the M4-POWER power unit chassis	45
2.7	Installing the media modules	46
2.8	Installing SFP/XFP transceivers (optional)	48
2.9	Connecting the supply voltage, starting up	48
2.10	Wiring and assembling the signal contact	49
2.11	Connecting the data lines	50
3	Basic set-up	51
4	Maintenance and service	52
5	Deinstallation	53
5.1	Deinstalling the media modules	53
5.2	Deinstalling the SFP/XFP transceivers	53
5.3	Deinstalling the M4-AIR... plug-in fan unit	54
6	Technical data	55
A	Further Support	65

Safety instructions

■ **Certified usage**

Only use the device for application cases that are described in the Hirschmann product information, including this manual. Only operate the device according to the technical specifications.

■ **Supply voltage**

For **every** supply voltage to be connected, make sure the following requirements are met:

- ▶ Devices with DC power supply are designed for operation with a safety extra-low voltage. Accordingly, only PELV or SELV circuits with voltage restrictions in line with IEC/EN 60950-1 may be connected to the DC supply voltage connections.
- ▶ The supply voltage complies with the description on the data plate of your device.
- ▶ The complete defective plug-in power supply unit must be changed.
- ▶ For safety reasons, the fuse installed in the plug-in power supply units may not be changed.
- ▶ Only switch on the device when the housing is closed. Close all empty slots with a covering panel.
- ▶ Screw the power supply units to the housing before connecting the input voltage.
- ▶ If you are using the M4-POWER power unit chassis: Check the configuration of the connection plugs and the power supply cable to the switch chassis before you connect an external voltage to the M4-POWER inputs.
- ▶ Only use connection cables that are permitted for a temperature range from 0 °C to 60 °C.
- ▶ Only use copper wire/conductors of class 1, 75 °C.
- ▶ Only use the M4-POWER CABLE for the redundant power supply.
- ▶ Only use the M4-POWER power supply unit for the redundant power supply. Do not connect any other external voltage source.
- ▶ Use undamaged parts.

■ **Safe grounding**

Make sure you ground the devices assembled in the switch cabinet safely. In particular, check the supply voltage connections if they are not connected directly to the supply cable (e.g. when using power strips).

■ **Signal contacts (“FAULT”)**

Only connect SELV circuits with voltage restrictions in line with IEC/EN 60950-1 to the signal contacts.

■ Shielded ground

The shielded ground wire of the twisted pairs lines is connected to the front panel as a conductor.

- Beware of possible short circuits when connecting a cable section with conductive shield braiding.

■ Housing

Only technicians authorized by the manufacturer are permitted to open the housing.

The device is grounded via the voltage supply socket.

- ▶ Reduced air flow: Install the device in the switch cabinet in such a way that ensures sufficient air flow for operating the device safely.
- ▶ Keep the ventilation slits free to ensure good air circulation.
- ▶ Make sure there is at least 10 cm of space in front of the ventilation slits of the housing.
- ▶ Never operate the device without a plug-in fan.
[See "Fan" on page 21.](#)
- ▶ Never insert sharp objects (narrow screwdrivers, wires, etc.) into the inside of the product or into the connection terminals for the supply voltage and the signal contact.
- ▶ Do not touch the connection terminals for the supply voltage and the signal contact.
- ▶ Close all empty slots with a covering panel.
- ▶ Modules, fans and power supply units of a switched-on device may only be installed or removed by an electrician.
- ▶ Fans are subject to natural wear. The failure of one or more fans in the plug-in fan can have a negative effect on the operation and life span of the device, or can lead to a total failure.

Therefore, you should use the device's monitoring function for the fan and the temperature.

Depending on your installation conditions, you can continue operating your device when one fan fails.

Note the temperature display of your device:

- In the Command Line Interface, with the command: show temperature.

- In the graphical user interface, in the Basic Settings dialog: system, temperature

The temperature display must never exceed the maximum value (see following list):

Device	Maximum Value
MACH4002-48+4G	+75 °C
MACH4002-24G	+80 °C
MACH4002-24G+3XG	+80 °C
MACH4002-48G	+80 °C
MACH4002-48G+3XG	+80 °C

- ▶ The basic board must not be removed.
Removing the basic board invalidates the guarantee.
- ▶ The chassis should be installed in the horizontal position.
- ▶ After the device is switched off, the fan blades continue rotating for a number of seconds. Do not reach into a rotating fan!
- ▶ The internal workings of the basic device are not for users! Do not reach inside a switched-on device because of the danger caused by high energy densities.
- ▶ When fully equipped with media modules, the device weighs up to 10 kg. Please comply with the legally stipulated maximum weight when dealing with heavy objects.
- ▶ If you are operating the device in a 19" switch cabinet: install sliding/mounting rails for supporting the weight of the device.
[See "Mounting in a switch cabinet" on page 40.](#)

■ Environment

Only operate the device at the specified ambient temperature (temperature of the ambient air at a distance of up to 5 cm from the device) and at the specified relative humidity.

- ▶ Select the assembly location such that climatic limit values specified in the technical data are maintained.
- ▶ Only to be used in an environment with the pollution degree specified in the technical data.
- ▶ Increased ambient temperature: When you are operating the device in a closed switch cabinet or together with other devices in a switch cabinet, the ambient temperature in the switch cabinet can be higher than the ambient temperature in the room. Only install the device in an ambient temperature in line with the maximum ambient temperature specified by the manufacturer: t_{\max} .
- ▶ Mechanical stress: Install the device in a switch cabinet in such a way that rules out hazardous conditions due to severe mechanical stress.

■ Qualification requirements for personnel

Qualified personnel as understood in this manual and the warning signs, are persons who are familiar with the setup, assembly, startup, and operation of this product and are appropriately qualified for their job. This includes, for example, those persons who have been:

- ▶ trained or directed or authorized to switch on and off, to ground and to label power circuits and devices or systems in accordance with current safety engineering standards;
- ▶ trained or directed in the care and use of appropriate safety equipment in accordance with the current standards of safety engineering;
- ▶ trained in providing first aid.

■ **General safety instructions**

This device is operated by electricity. You must follow precisely the prescribed safety requirements for the voltage connections in this document.

See “Supply voltage” on page 5.

Non-observance of these safety instructions can cause material damage and/or injuries.

- ▶ Only appropriately qualified personnel should work on this device or in its vicinity. The personnel must be thoroughly familiar with all the warnings and maintenance procedures outlined in this operating manual.
- ▶ The proper and safe operation of this device depends on proper handling during transportation, proper storage and assembly, and conscientious operation and maintenance procedures.
- ▶ Never start operation with damaged components.
- ▶ Only use the devices in accordance with this manual. In particular, observe all warnings and safety-related information.
- ▶ Any work that may be required on the electrical installation may only be carried out by personnel trained for this purpose.

Note: LED or LASER components in compliance with IEC 60825-1 (2007):

CLASS 1 LASER PRODUCT
CLASS 1 LED PRODUCT

■ **National and international safety regulations**

- Make sure that the electrical installation meets local or nationally applicable safety regulations.

■ **ESD Guidelines**

The media modules are equipped with electrostatically sensitive components. These can be destroyed, or their life cycles reduced, by the effects of an electrical field or by a charge equalization if the card is touched.

For this reason, the cards are packaged in a conductive ESD protective bag on delivery. The packaging can be reused.

Make sure you adhere to the following protection measures for electrostatically endangered assemblies:

- Create electrical equipotential bonding between yourself and your environment, e.g. using a wristband, which you clamp to the basic device (knurled screw of an interface card). When the power supply cable is connected, the basic device is grounded via the power supply connection.
- Only now do you take the card out of the conductive bag.

- Outside the basic device, only store the cards in a conductive ESD protective bag.

ESD protective field equipment is available for the safe handling of electrostatically endangered assemblies.

You can find more information about electrostatically endangered assemblies in DIN/IEC 47 (Sec) 1330; February 1994 Edition and DIN EN 100 015.

■ **CE marking**

The devices comply with the regulations contained in the following European directives:

2011/65/EU (RoHS)

Directive of the European Parliament and of the Council on the restriction of the use of certain hazardous substances in electrical and electronic equipment.

2006/95/EC

Directive of the European Parliament and the council for standardizing the regulations of member states with regard to electrical equipment to be used within specific voltage ranges.

2004/108/EC (EMC)

Directive of the European Parliament and the council for standardizing the regulations of member states with regard to electromagnetic compatibility.

In accordance with the above-named EU directive(s), the EU conformity declaration will be at the disposal of the relevant authorities at the following address:

Hirschmann Automation and Control GmbH
Stuttgarter Str. 45-51
72654 Neckartenzlingen
Tel.: +49 1805 141538

The product can be used in the industrial sector.

- ▶ Interference immunity: EN 61000-6-2
- ▶ Emitted interference: EN 55022
- ▶ Reliability: EN 60950-1

You will find more information on norms and standards here:

[“Underlying norms and standards” on page 64](#)

Warning! This is a class A device. This device can cause interference in living areas, and in this case the operator may be required to take appropriate measures.

Note: The assembly guidelines provided in these instructions must be strictly adhered to in order to observe the EMC threshold values.

■ **FCC note**

This device complies with part 15 of the FCC rules. Operation is subject to the following two conditions: (1) this device may not cause harmful interference; (2) this device must accept any interference received, including interference that may cause undesired operation.

Appropriate testing has established that this device fulfills the requirements of a class A digital device in line with part 15 of the FCC regulations.

These requirements are designed to provide sufficient protection against interference when the device is being used in a business environment.

The device creates and uses high frequencies and can also radiate high frequencies, and if it is not installed and used in accordance with this operating manual, it can cause radio transmission interference. The use of this device in a living area can also cause interference, and in this case the user is obliged to cover the costs of removing the interference.

■ **Recycling note**

After usage, this device must be disposed of properly as electronic waste, in accordance with the current disposal regulations of your county, state, and country.

About this manual

The “Installation” user manual contains a device description, safety instructions, a description of the display, and the other information that you need to install the device.

The following manuals are available as PDF files on the CD/DVD supplied:

- ▶ Installation user manual
- ▶ Basic Configuration user manual
- ▶ Redundancy Configuration user manual
- ▶ Router Configuration user manual
- ▶ Reference manual for the graphical user interface
- ▶ Command Line Interface user manual

The Industrial HiVision Network Management Software provides you with additional options for smooth configuration and monitoring:

- ▶ Simultaneous configuration of multiple devices
- ▶ Graphical user interface with network layout
- ▶ Auto-topology discovery
- ▶ Event log
- ▶ Event handling
- ▶ Client/server structure
- ▶ Browser interface
- ▶ ActiveX control for SCADA integration
- ▶ SNMP/OPC gateway.

With the Industrial HiVision Network Management software, you increase your network security in industrial application areas:

- ▶ Ethernet Early Warning System
- ▶ Easy monitoring of industrial networks
- ▶ Fast display
- ▶ Interface with diagnostic and configuration programs
- ▶ Low deployment cost

Legend

The symbols used in this manual have the following meanings:

▶	Listing
□	Work step
■	Subheading

1 Description

1.1 General device description

The modular, industry-compatible MACH4000 Gigabit Ethernet system is used as an industrial backbone system, and also in applications with high data volumes, such as Voice/Video over IP.

The MACH4000 is a modular, industry-compatible Gigabit Ethernet system in a 19" chassis that is also suitable for use as an industrial backbone system.

The MACH4000 devices are designed for the special requirements of industrial automation. They meet the relevant technical standards, provide very high operational reliability, even under extreme conditions, and also long-term reliability and flexibility. The power is supplied by an AC or DC power unit at the back of the device, or it is supplied redundantly via a power unit chassis with up to three hot-swappable plug-in power units. The switches and the power unit chassis are suitable for mounting in the 19" rack.

The devices allow you to set up switched industrial Ethernet networks that conform to the IEEE 802.3 standard.

The HIPER-Ring redundancy concept enables you to quickly carry out a reconfiguration, and also a simple configuration with only one additional connection.

The diagnosis LEDs for displaying the operating parameters provide a quick overview.

There are convenient options for managing the device. Administer your devices via:

- ▶ a Web browser
- ▶ SSH
- ▶ Telnet
- ▶ HiDiscovery (Software for putting the device into operation)
- ▶ management software (such as Industrial HiVision)
- ▶ a V.24 interface (locally on the device)

The devices provide you with a large range of functions, which the manuals for the operating software inform you about. You will find these manuals as PDF files on the enclosed CD/DVD, or you can download them from the Internet on the Hirschmann product pages (www.hirschmann.com).

The Hirschmann network components help you ensure continuous communication across all levels of the company.

The addition, to the MACH family of backbone switches, of the RS20/RS22/RS30/RS32/RS40 switches of the Open Rail family and the MICE family, the BAT wireless transmission system, the EAGLE security system, and products for the LION control room, provides continuous communication across all levels of the company.

1.2 MACH4000 Basic Device

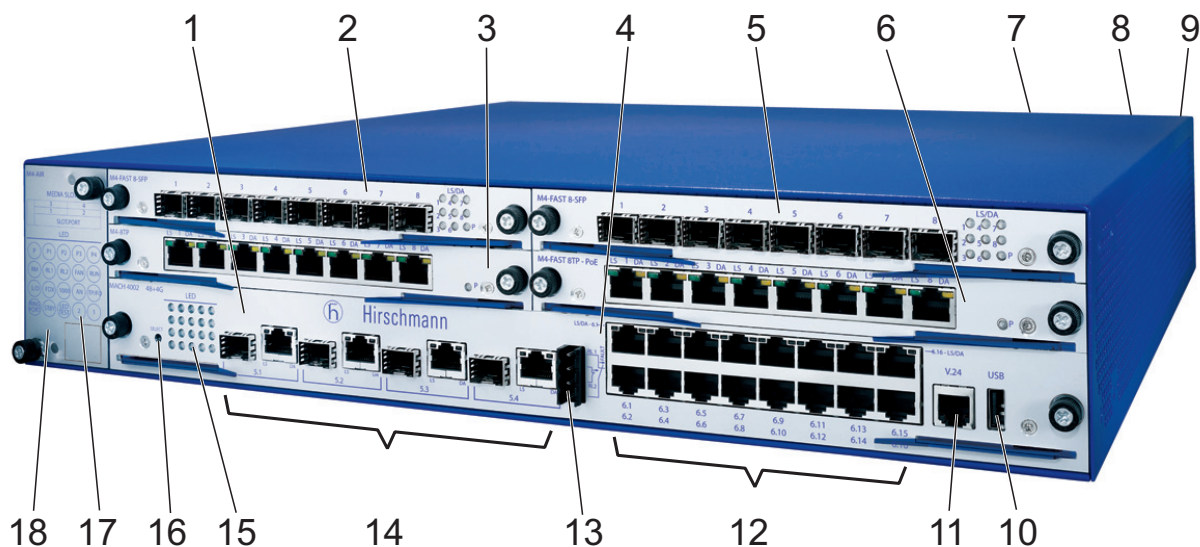

Figure 1: Structure of the basic device (example: MACH4002-48+4G)

- 1 - Basic board (integrated) ports 5.1 to 5.4
- 2 - Media module 3 (plug-in unit)
- 3 - Media module 1 (plug-in unit)
- 4 - Basic board (integrated) ports 6.1 to 6.16
- 5 - Media module 4 (plug-in unit)
- 6 - Media module 2 (plug-in unit)
- 7 - Back of device: power supply unit
- 8 - External connection to M4-POWER
- 9 - External connection to M4-POWER
- 10 - USB socket
- 11 - V.24 access for external management
- 12 - Sixteen TP ports (ports 6.1 to 6.16)
- 13 - 2 switchable signal contacts
- 14 - 4 combo ports (ports 5.1 to 5.4)
- 15 - LED display elements
- 16 - SELECT button
- 17 - Label for the LED display elements
- 18 - Plug-in fan

Depending on the MACH4000 device variant, the device provides you with the following ports and slots for equipping it with media modules:

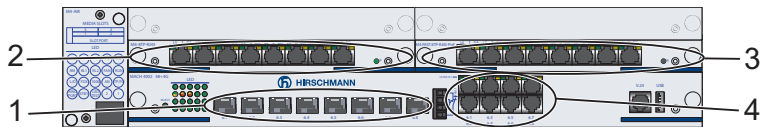

Figure 2: Ports and media module slots on the MACH4002-24G

- 1 - Basic board (integrated), ports 6.1 to 6.8, SFP 100/1000 Mbit/s (alternatively to RJ45 ports 6.1 to 6.8)
- 2 - Media module 1 (plug-in unit), ports 1.1 to 1.8, 10/100/1000 Mbit/s
- 3 - Media module 2 (plug-in unit), ports 2.1 to 2.8, 10/100/1000 Mbit/s
- 4 - Basic board (integrated), ports 6.1 to 6.8, RJ45 10/100/1000 Mbit/s

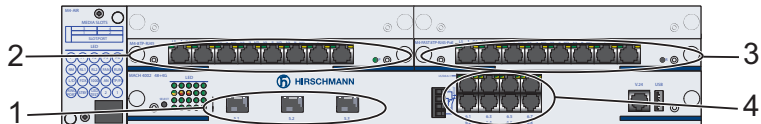

Figure 3: Ports and media module slots on the MACH4002-24G+3X

- 1 - Basic board (integrated), ports 5.1 to 5.3, XFP 10 Gbit/s
- 2 - Media module 1 (plug-in unit), ports 1.1 to 1.8, 10/100/1000 Mbit/s
- 3 - Media module 2 (plug-in unit), ports 2.1 to 2.8, 10/100/1000 Mbit/s
- 4 - Basic board (integrated), ports 6.1 to 6.8, RJ45 10/100/1000 Mbit/s

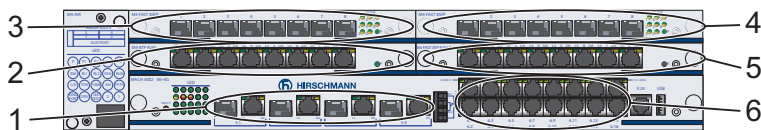

Figure 4: Ports and media module slots on the MACH4002-48+4G

- 1 - Basic board (integrated), ports 5.1 to 5.4, RJ45 10/100/1000 Mbit/s, alternatively SFP 1000 Mbit/s
- 2 - Media module 1 (plug-in unit), ports 1.1 to 1.8, 10/100 Mbit/s
- 3 - Media module 3 (plug-in unit), ports 3.1 to 3.8, 10/100 Mbit/s
- 4 - Media module 4 (plug-in unit), ports 4.1 to 4.8, 10/100 Mbit/s
- 5 - Media module 2 (plug-in unit), ports 2.1 to 2.8, 10/100 Mbit/s
- 6 - Basic board (integrated), ports 6.1 to 6.16, RJ45 10/100 Mbit/s

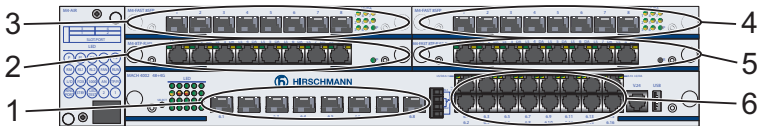

Figure 5: Ports and media module slots on the MACH4002-48G
 1 - Basic board (integrated), ports 6.1 to 6.8, SFP 100/1000 Mbit/s (alternatively to RJ45 ports 6.1 to 6.8)
 2 - Media module 1 (plug-in unit), ports 1.1 to 1.8, 10/100/1000 Mbit/s
 3 - Media module 3 (plug-in unit), ports 3.1 to 3.8, 10/100/1000 Mbit/s
 4 - Media module 4 (plug-in unit), ports 4.1 to 4.8, 10/100/1000 Mbit/s
 5 - Media module 2 (plug-in unit), ports 2.1 to 2.8, 10/100/1000 Mbit/s
 6 - Basic board (integrated), ports 6.1 to 6.16, RJ45 10/100/1000 Mbit/s

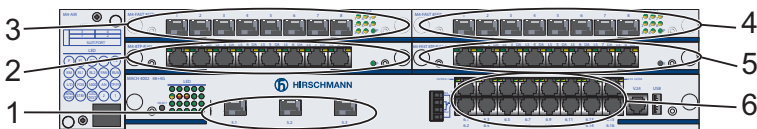

Figure 6: Ports and media module slots on the MACH4002-48G+3X
 1 - Basic board (integrated), ports 5.1 to 5.3, XFP 10 Gbit/s
 2 - Media module 1 (plug-in unit), ports 1.1 to 1.8, 10/100/1000 Mbit/s
 3 - Media module 3 (plug-in unit), ports 3.1 to 3.8, 10/100/1000 Mbit/s
 4 - Media module 4 (plug-in unit), ports 4.1 to 4.8, 10/100/1000 Mbit/s
 5 - Media module 2 (plug-in unit), ports 2.1 to 2.8, 10/100/1000 Mbit/s
 6 - Basic board (integrated), ports 6.1 to 6.16, RJ45 10/100/1000 Mbit/s

Basic device	Maximum port number of the device, in brackets number of intalled ports on the basic board				Max. number of media modules	Max. PoE power
	TP ports, 10/100 Mbit/s	TP ports, 10/100/1000 Mbit/s	TP/SFP combo ports, 10/100/1000 Mbit/s	XFP slots, 10 Gbit/s	10/100 Mbit/s	1000 Mbit/s
4002-48+4G	48 (16)	-	4 (4 ^a)	- (-)	4 ^b	137 W
4002-24G	- (-)	16 (-)	8 (8 ^c)	- (-)	2	163 W
4002-48G	- (-)	48 (8)	8 (8 ^c)	- (-)	4	110 W
4002-24G+3X	- (-)	24 (8)	- (-)	3 (3)	2	157 W
4002-48G+3X	- (-)	48 (16)	- (-)	3 (3)	4	106 W

Table 1: Maximum number of ports and media modules and maximum PoE power

- a. SFP 1000 Mbit/s
- b. M4-8TP-RJ45, M4-8TP-RJ45-PoE or M4-FAST 8-SFP
- c. SFP 100/1000 Mbit/s

The devices comply with the specifications of the standards:

- ▶ ISO/IEC 8802-3u 100BASE-TX/-1000BASE-TX
- ▶ ISO/IEC 8802-3 100BASE-FX
- ▶ ISO/IEC 8802-3 1000BASE-SX/LX
- ▶ ISO/IEC 8802-3 10GBASE-SR/LR

The MACH4000 basic devices are 2 height modules high (approx. 88mm) and, depending on the device variant and the connected media, they provide you with

- ▶ up to 48 Fast Ethernet ports
- ▶ up to 48 Gigabit Ethernet ports
- ▶ up to three 10 Gigabit Ethernet ports

See [“Maximum number of ports and media modules and maximum PoE power”](#) on page 16.

You can order the basic devices with different ranges of functions ([see on page 61 “Order numbers/product description”](#)). The software supplied defines the range of functions:

- ▶ Software Layer 2 Professional (L2P)
- ▶ Software Layer 3 Enhanced (L3E), static routing
- ▶ Software Layer 3 Professional (L3P), Multicast routing

Depending on the device variant, a basic device has 2 or 4 slots for media modules (media modules 1-2 or 1-4) that are hot-swappable and each provide 8 Fast Ethernet/Gigabit Ethernet ports. The media modules differ with regard to the number of interfaces and the media type for connecting segments.

The integrated basic board is located below the media modules.

The basic board provides the following:

- ▶ In the MACH4002-48+4G it has 4 Gigabit Ethernet ports (combo ports, i.e. SFP slots for 1000BASE-SX or 1000BASE-LX and RJ45 sockets for 10/100/1000BASE-TX, media module 5) and 16 Fast Ethernet ports (10/100BASE-TX, media module 6).
- ▶ In the MACH4002-24G it has 8 Gigabit Ethernet ports (SFP slots for 100BASE-FX, 1000BASE-SX/LX, media module 6, alternatively to the RJ45 ports 6.1 to 6.8) and 8 Gigabit Ethernet RJ45 ports (10/100/1000BASE-TX, media module 6).
- ▶ In the MACH4002-48G it has 8 Gigabit Ethernet ports (SFP slots for 100BASE-FX, 1000BASE-SX/LX, media module 6, alternatively to the RJ45 ports 6.1 to 6.8) and 16 Gigabit Ethernet RJ45 ports (10/100/1000BASE-TX, media module 6).
- ▶ In the MACH4002-24G+3XP it has three 10-Gigabit Ethernet ports (XFP slots for 10GBASE-SR/LR, media module 5) and 8 Gigabit Ethernet RJ45 ports (10/100/1000BASE-TX, media module 6).
- ▶ In the MACH4002-24G+3XP it has three 10-Gigabit Ethernet ports (XFP slots for 10GBASE-SR/LR, media module 5) and 16 Gigabit Ethernet RJ45 ports (10/100/1000BASE-TX, media module 6).

Along with the 10-Gigabit (if present), Gigabit and Fast Ethernet ports, the front of the basic board also has the following connections:

- ▶ A USB socket for connecting an ACA21-USB AutoConfiguration Adapter
- ▶ A V.24 socket for the network management connection
- ▶ Two signal contacts that are integrated on one socket together

The LED display block on the left side of the basic board informs you about the status of the device. You use the SELECT button to define the meaning of the LED displays.

At the front left of the basic chassis of the MACH4000, there is a replaceable plug-in fan.

On the back of the device there is a slot for a power supply unit:

- ▶ AC plug-in power unit 300 W
- ▶ 24 V DC plug-in power unit 300 W (2 connections coupled via diodes)
- ▶ 48 V DC plug-in power unit 300 W (2 connections coupled via diodes)

The back of the device also has two external inputs (voltage input Nos. 3 + 4) for the redundant voltage supply via the M4-POWER power unit chassis.

The M4-POWER power unit chassis enables redundant power supply. The power supply cable(s) between M4-POWER and MACH4000 is/are connected at the back of the MACH4000 device.

M4-POWER provides you with 3 slots for plug-in power units:

- ▶ AC plug-in power unit 300W
- ▶ 24 VDC plug-in power unit 300W (2 connections coupled via diodes)
- ▶ 48 VDC plug-in power unit 300W (2 connections coupled via diodes)

1.3 Supply voltage

On the back of the device there is a slot for a power supply unit (AC or DC) and two inputs for the redundant power supply via the M4-POWER power unit chassis. Both inputs are uncoupled.



Figure 7: Back side of the MACH4000 basic device
1 - M4-POWER connection (voltage input P3-1/P3-2, external)
2 - M4-POWER connection (voltage input P4-1/P4-2, external)
3 - Slot for slide-in power supply unit (voltage input P1 and, if required, P2)

With redundant supply, the power supply unit with the higher output voltage supplies the device on its own. The supply voltage is electrically isolated from the housing.

With non-redundant supply of the mains voltage, the device reports a power failure. You can avoid this message by changing the configuration in the management, or, with power supply units of the same type, by feeding the supply voltage in via both inputs.

The 0V connections within a DC module (M4-...-...VDC 300W) are connected with each other.

The DC modules (M4-...-...VDC 300W) are grounded via the 3-pin DC socket connection.

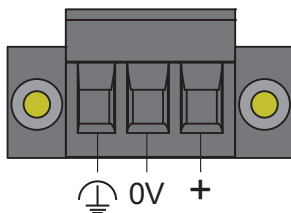

Figure 8: Plug connections at the DC socket (external voltage supply)

1.3.1 Supply voltage on the back of the device

■ Plug-in power units for MACH4000 switch chassis

- ▶ M4-S-AC/DC 300W
- ▶ M4-S-24VDC 300W, 2 inputs for redundant power supply
- ▶ M4-S-48VDC 300W, 2 inputs for redundant power supply

See “Order numbers/product description” on page 61.

Note: The plug-in power units of the M4-POWER power unit chassis cannot be used for the switch chassis.

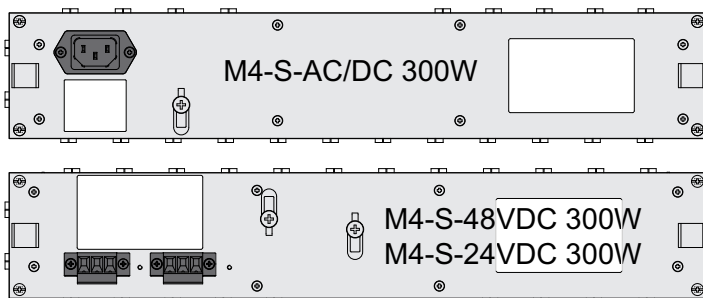

1.3.2 M4-POWER power unit chassis

Note: Consider the sequence for the cabling of the power unit chassis. See “Mounting the power unit chassis, connecting with the MACH4000 device” on page 43.

The M4-POWER power unit chassis enables redundant power supply. It has three slots for plug-in power units. The plug-in power units can be replaced during operation (hot-swappable).

Depending on the plug-in power units connected, you can use an M4-POWER power unit chassis to implement the redundant power supply for several MACH4000 devices.

- You connect the M4-POWER power units to the M4-POWER connection on the back of the MACH4000 device using the power supply cable supplied with the M4-P-xx plug-in power units.

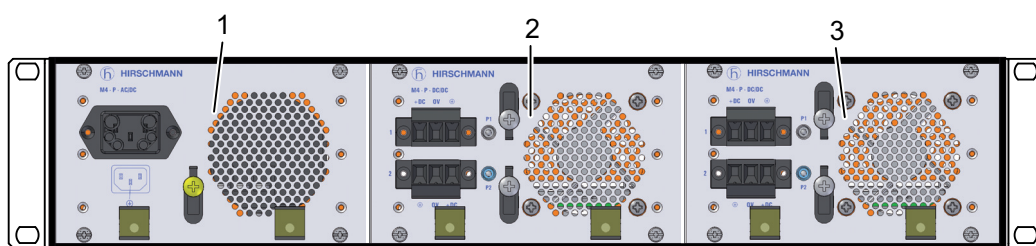

Figure 9: M4-POWER power unit chassis, front side of the device (mounting with up to 3 power units)

- 1 - Power unit 1
- 2 - Power unit 2
- 3 - Power unit 3

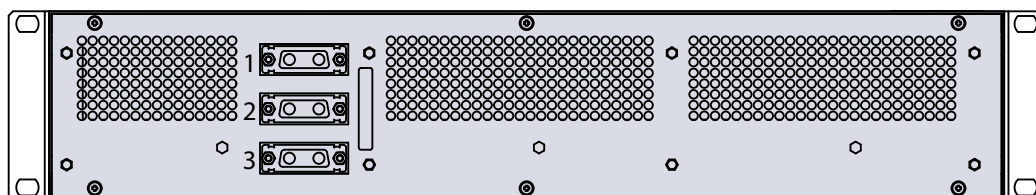

Figure 10: M4-POWER power unit chassis, back side of the device

■ Plug-in power units for M4-POWER power unit chassis

- ▶ M4-P-AC/DC 300W
 - ▶ M4-P-24VDC 300W, 2 inputs for redundant power supply
 - ▶ M4-P-48VDC 300W, 2 inputs for redundant power supply
- (see on page 61 “Order numbers/product description”).

Note: The plug-in power units of the M4-POWER power unit chassis cannot be used for the switch chassis.

1.4 Fan

Note: Read the safety guidelines under “Housing” on page 6.



1.4.1 M4-AIR plug-in fan

Operate the MACH4000 switch chassis exclusively with plug-in fans as described in the following.

NOTE

OVERHEATING OF THE DEVICE

Depending on the ambient temperature, the device can be operated for a maximum of one to two minutes with the fan unit removed.

Non-adherence to these instructions can lead to material damage.

On the front of the MACH4000 chassis the M4-AIR or M4-AIR-L plug-in fan is located on the left. You can replace the plug-in fan during operation.

See “Installing the M4-AIR... plug-in fan unit” on page 44.

See “Deinstalling the M4-AIR... plug-in fan unit” on page 54.

- ▶ **M4-AIR:** Plug-in fan for MACH4000 switch chassis without temperature sensor for use in ambient temperatures up to a maximum of +60 °C.
- ▶ **M4-AIR-L:** Plug-in fan for MACH4000 switch chassis with reduced fan speed for use in ambient temperatures up to a maximum of +40 °C.

Note: Devices with the M4-AIR-L plug-in fan are suitable for use in an ambient temperature up to a maximum of +40 °C.

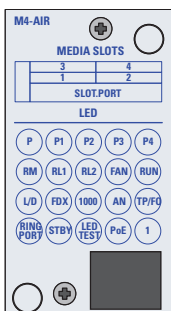
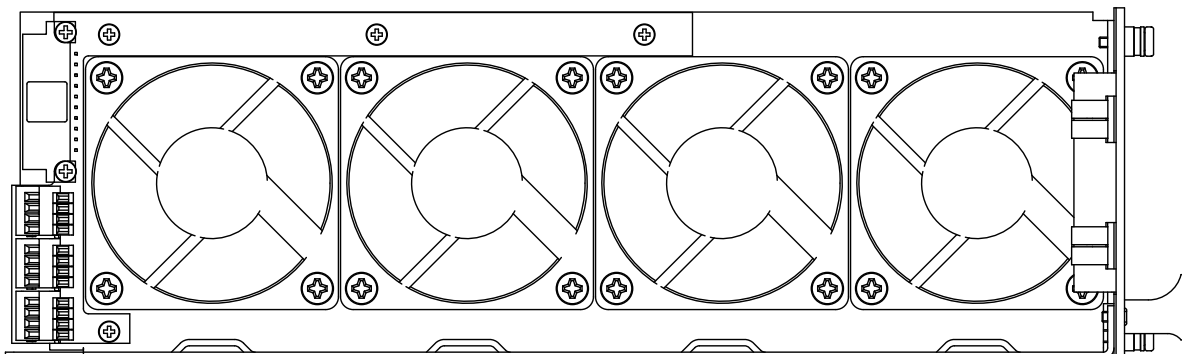

M4-AIR

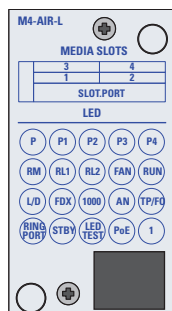

M4-AIR-L

Figure 11: M4-AIR and M4-AIR-L plug-in fans
Side and front views

1.4.2 Monitoring temperature and fan

■ Fan monitoring

Every individual fan sends a speed-dependent signal to the basic system. The fan monitoring displays the failure of one or more individual fans.

■ The effect of insufficient ventilation

If the device is insufficiently ventilated by its fans, this either causes the assemblies to age faster (MTBF value) or triggers error statuses, and it usually leads to transmission errors on the Ethernet connections.

■ Temperature difference

The difference between the ambient temperature and the circuit board (PCB) temperature is primarily independent of the ambient temperature:

MACH4000 device	Ambient - PCB temperature difference with all fans at full speed	Ambient - PCB temperature difference with all fans at half speed
MACH4002-48+4G	+15 K	+20 K
MACH4002-24G/48G	+20 K	+27 K

Table 2: Ambient - PCB temperature difference at full and half fan speed

■ Recommendation for temperature monitoring

Use the following table (based on half speed for all fans) to monitor the temperature of your device. Switch the device off if the temperature values entered in the table are exceeded. This ensures that the device is sufficiently ventilated and is not operated at its limit.

MACH4000 device	Printed circuit board (PCB) temperature threshold value
MACH4002-48+4G	Ambient temperature + 20 K
MACH4002-24G/48G	Ambient temperature + +27 K

Table 3: Temperature monitoring

1.5 Integrated basic board

Depending on the device variant, the integrated basic board provides you with different numbers and types of port.

See “Order numbers/product description” on page 61.

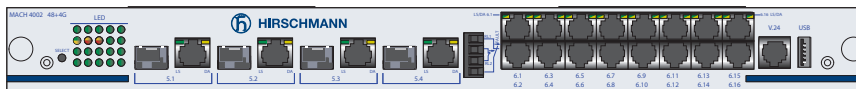

Figure 12: Basic board MACH4002-48+4G



Figure 13: Basic board MACH4002-24G



Figure 14: Basic board MACH4002-48G

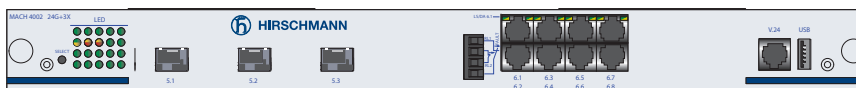

Figure 15: Basic board MACH4002-24G+3X

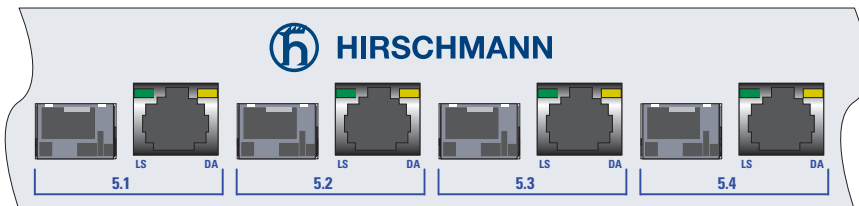

Figure 16: Basic board MACH4002-48G+3X

1.5.1 Left area of basic board

■ Four Gigabit Ethernet ports (combo) in MACH4002-48+4G

There are four Gigabit Ethernet ports (ports number 5.1 to 5.4) for connecting network segments on the left side of the basic board. The ports are RJ45 sockets, each with two integrated LEDs and an SFP slot.



If an SFP transceiver is mounted, the RJ45 socket is switched off. The LEDs each apply to the active port. You can use the SELECT button to test the TP or FO connections.

See [“Order numbers/product description” on page 61](#).

■ Eight Gigabit Ethernet ports (Combo) in MACH4002-24G and MACH4002-48G

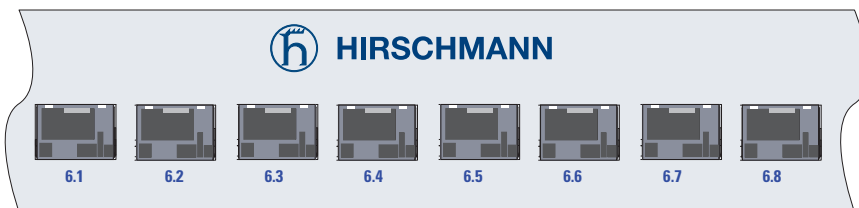

There are eight Gigabit Ethernet ports (ports number 6.1 to 6.8) for connecting network segments on the left side of the basic board. These are SFP slots that are used as alternatives to RJ45 ports 6.1 to 6.8.

See [“Order numbers/product description” on page 61](#).

■ Three 10-Gigabit Ethernet ports (XFP) in MACH4002-24G+3X and MACH4002-48G+3X

There are three 10-Gigabit Ethernet ports (ports number 5.1 to 5.3) for connecting network segments on the left side of the basic board. These ports are XFP slots.

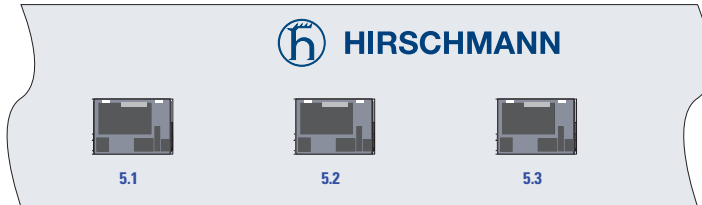

The following 10-Gigabit Ethernet XFP transceivers are available to you for the MACH4002-...-3X:

- M-XFP-SR/LC
- M-XFP-LR/LC
- M-XFP-ER/LC
- M-XFP-ZR/LC

See “Order numbers/product description” on page 61.

1.5.2 Right area of basic board

■ 16 Fast Ethernet ports in MACH4002-48+4G

There are sixteen 10/100BASE-TX ports (ports number 6.1 to 6.16) for connecting network segments on the right side of the basic board. These ports are RJ45 sockets.

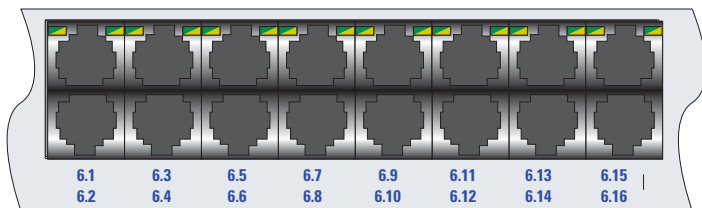

■ 16 Gigabit Ethernet ports in MACH4002-48G and MACH4002-48G+3X

There are sixteen 10/100/1000BASE-TX ports (ports number 6.1 to 6.16) for connecting network segments on the right side of the basic board.

These ports are RJ45 connections.

In the MACH4002-48G, the RJ45 ports 6.1 to 6.8 can be used as alternatives to the SFP ports 6.1 to 6.8 on the left side of the basic board (combo ports).

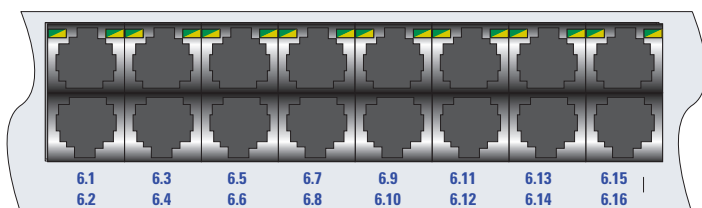

■ 8 Gigabit Ethernet ports in MACH4002-24G and MACH4002-24G+3X

There are eight 10/100/1000BASE-TX ports (ports number 6.1 to 6.8) for connecting network segments on the right side of the basic board. These ports are RJ45 sockets.

In the MACH4002-24G, the RJ45 ports 6.1 to 6.8 can be used as alternatives to the SFP ports 6.1 to 6.8 on the left side of the basic board (combo ports).

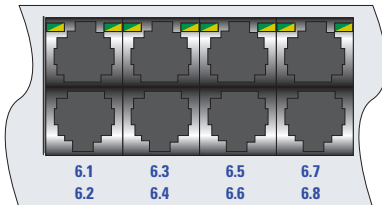

1.6 Signal contact

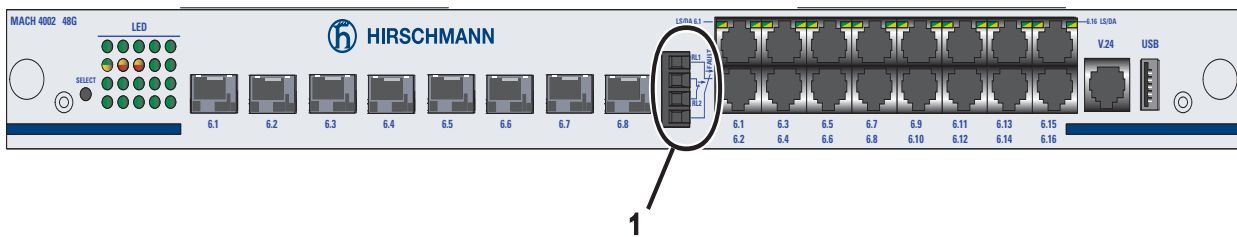

Figure 17: 4-pin signal contact

The signal contact is a potential-free relay contact. The device allows you to perform remote diagnosis via the signal contact. In the process, the device signals events such as a line interruption. When an event occurs, the device opens the relay contact and interrupts the closed circuit. The management setting specifies which events switch a contact. You can also use the management to switch the signal contact manually and thus control external devices.

1.7 Media modules



M4-8TP-RJ45

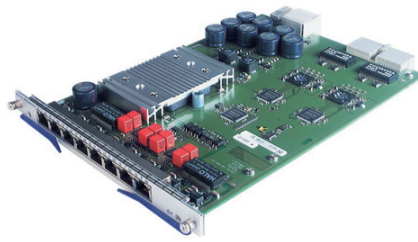

M4-FAST 8TP-RJ45-PoE

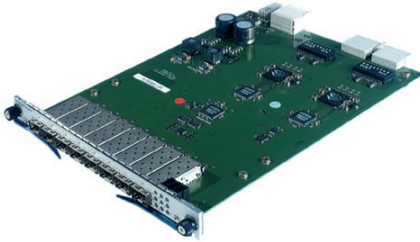

M4-FAST 8-SFP

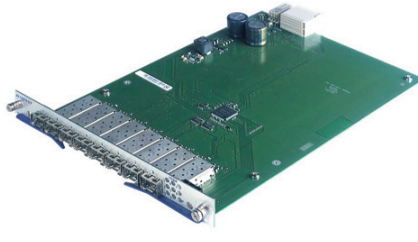

M4-GIGA 8-SFP

Figure 18: Fast Ethernet media modules and Gigabit Ethernet media modules

MACH4000 device	M4-8TP-RJ45	M4-FAST 8TP-RJ45 PoE	M4-FAST 8-SFP	M4-GIGA 8-SFP
MACH4002-48+4G	0 - 4 Media modules	0 - 4 Media modules ^a	0 - 4 Media modules	0 Media modules
MACH4002-24G...	0 - 2 Media modules	0 - 2 Media modules ^a	0 - 2 Media modules	0 - 2 Media modules
MACH4002-48G...	0 - 4 Media modules	0 - 4 Media modules ^a	0 - 4 Media modules	0 - 4 Media modules

Table 4: Possible media module configuration in MACH4000 devices

a. Note the PoE capacity limits (see “Maximum number of ports and media modules and maximum PoE power” on page 16).

1.7.1 M4-8TP-RJ45

The M4-8TP-RJ45 media module provides you with eight 10/100/1000BASE-TX ports (RJ45 sockets) for connecting network segments.

Note: When used in the MACH4002-48+4G, the media module provides you with eight 10/100BASE-TX ports.

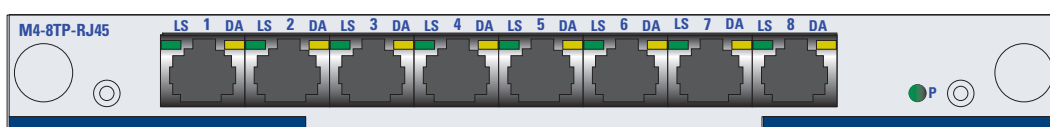

1.7.2 M4-FAST 8TP-RJ45-PoE

The M4-FAST 8TP-RJ45 PoE media module provides you with eight 10/100BASE-TX ports (RJ45 sockets) for connecting network segments. It supports Power over ETHERNET on data lines in compliance with IEEE 802.3af.

The maximum power available to you for all ports combined for PoE applications is listed in [“Maximum number of ports and media modules and maximum PoE power”](#) on page 16.

For each chassis you can use up to four M4-FAST 8TP-RJ45 PoE media modules. The number of ports supplying PoE terminal devices with power depends on the total power available. The power is supplied via the data lines. The individual ports are not electrically insulated from each other.

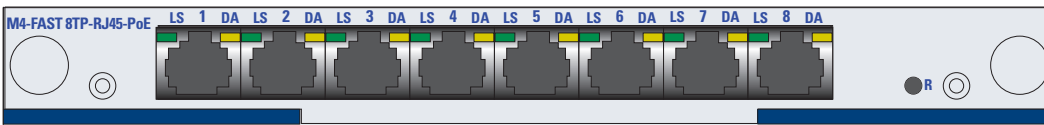

1.7.3 M4-FAST 8-SFP

The M4-FAST 8-SFP media module has eight 100BASE-FX ports (SFP slots for mounting SFP transceivers).

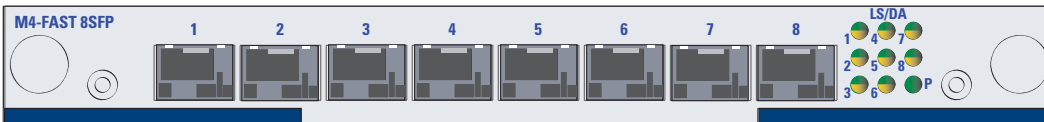

The following Fast Ethernet SFP transceivers are available to you for the M4-FAST 8-SFP media module:

- ▶ Fast Ethernet SFP transceivers:
 - M-FAST SFP-MM/LC
 - M-FAST SFP-SM/LC
 - M-FAST SFP-SM/LC
 - M-FAST SFP-SM+/LC
 - M-FAST SFP-LH/LC

See [“Order numbers/product description”](#) on page 61.

1.7.4 M4-GIGA 8-SFP

The M4-GIGA 8-SFP media module has eight 100/1000BASE-FX ports (SFP slots for mounting SFP transceivers).

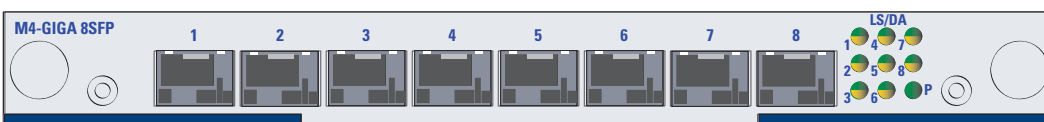

The following SFP transceivers are available to you for the M4-GIGA 8-SFP media module:

► Gigabit Ethernet SFP transceivers:

- M-SFP-SX/LC
- M-SFP-LX/LC
- M-SFP-LX+/LC
- M-SFP-LH/LC
- M-SFP-LH+/LC
- M-SFP-MX/LC

► Fast Ethernet SFP transceivers:

- M-FAST SFP-MM/LC
- M-FAST SFP-SM/LC
- M-FAST SFP-SM+/LC
- M-FAST SFP-LH/LC

See “Order numbers/product description” on page 61.

1.8 SFP/XFP transceiver

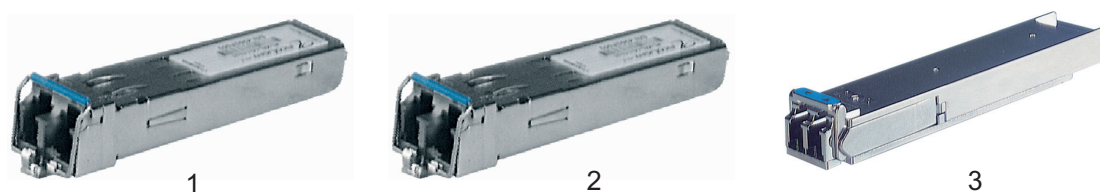

Figure 19: SFP transceiver and XFP transceiver

1 – Fast Ethernet F/O SFP transceiver

2 – Gigabit Ethernet F/O SFP transceiver

3 – 10-Gigabit Ethernet F/O XFP transceiver

SFP is the acronym for Small Form-factor Pluggable which is also commonly known as mini-GBIC (GigaBit Interface Converter).

Both Fast Ethernet SFP transceivers and Gigabit Ethernet SFP transceivers are available for your device.

XFP transceivers are slightly larger than SFP transceivers. They support 10-Gigabit Ethernet only.

Note: Only use Hirschmann SFP/XFP transceivers.

1.9 Ethernet ports

1.9.1 10/100/1000 Mbit/s twisted pair connection

These connections are RJ45 sockets.

10/100/1000 Mbit/s TP ports enable the connection of terminal devices or independent network segments according to the IEEE 802.3 10BASE-T/100BASE-TX/1000BASE-T standard.

These ports support:

- ▶ Autonegotiation
- ▶ Autopolarity
- ▶ Autocrossing (if autonegotiation is activated)
- ▶ 1000 Mbit/s full duplex
- ▶ 100 Mbit/s half-duplex mode, 100 Mbit/s full duplex mode
- ▶ 10 Mbit/s half-duplex mode, 10 Mbit/s full duplex mode

Note: Some of these ports also support Power over Ethernet (PoE).
See “PoE ports” on page 31.

Delivery state: autonegotiation activated

The socket housing is electrically connected to the front panel.

The pin assignment corresponds to MDI-X.

Figure	Pin	Function	Ports with PoE support: PoE voltage feed
	1	BI_DB+	Minus terminal of the supply voltage
	2	BI_DB-	Minus terminal of the supply voltage
	3	BI_DA+	Plus terminal of the supply voltage
	4	BI_DD+	
	5	BI_DD-	
	6	BI_DA-	Plus terminal of the supply voltage
	7	BI_DC+	
	8	BI_DC-	

Table 5: Pin assignment of a 1000 MBit/s TP interface in MDI-X mode, RJ45 socket - for PoE with the power supplied via the wire pairs transmitting the signal

1.9.2 100 Mbit/s F/O connection

These ports are SFP slots.

100 MBit/s F/O ports enable the connection of terminal devices or independent network segments in compliance with the IEEE 802.3 100BASE-FX standard.

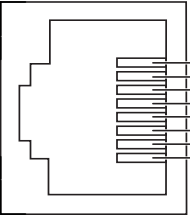
These ports support:

- ▶ Full or half duplex mode

Default setting: Full duplex

1.9.3 1000 Mbit/s F/O connection

These ports are SFP slots.

1000 Mbit/s F/O ports enable the connection of terminal devices or independent network segments according to the IEEE 802.3 1000BASE-SX/1000BASE-LX standard.

These ports support:

- ▶ Autonegotiation
- ▶ Full duplex mode

Delivery state: autonegotiation activated

Note: Make sure that you connect LH ports exclusively with LH ports, SX ports exclusively with SX ports, and LX ports exclusively with LX ports.

1.9.4 10 Gbit/s F/O connection

10 Gbit/s F/O ports enable the connection of terminal devices or independent network segments in compliance with the IEEE 802.3ae 10GBASE-SR/LR standard.

- ▶ Full duplex mode

Default setting: Full duplex

Note: Make sure that you connect SR ports exclusively with SR ports, LR ports exclusively with LR ports, ER ports exclusively with ER ports, and ZR ports exclusively with ZR ports.

1.9.5 PoE ports

The M4-FAST 8TP-RJ45 PoE media module supports Power over Ethernet (PoE) according to IEEE 802.3af.

Ports	PoE support
1 to 4	Yes
5 to 20	No

Table 6: Twisted-pair ports and PoE support

The PoE ports allow the connection and remote supply of, for example, IP telephones (Voice over IP), webcams, sensors, printer servers and WLAN access points. With PoE, power is supplied to these terminal devices via the twisted-pair cable.

The following applies to PoE ports:

- ▶ Max. Powered Device (PD) class 0 (15.4 W)
- ▶ The PoE voltage is supplied via the wire pairs transmitting the signal (phantom voltage).
- ▶ The individual ports (joint PoE voltage) are not electrically insulated from each other.

1.9.6 Combo ports

You have the option to alternatively connect F/O (via SFP transceivers) or twisted pairs to a combo port.

Media type	Connection options		
Twisted pair	Standard	ISO/IEC 8802-03 10BASE-T/100BASE-TX/1000BASE-T	
	Connection type	RJ45	
Fiber optic cable	either	Standard	ISO/IEC 8802-03 100BASE-FX
		Connection type	Fast Ethernet SFP transceiver
	or	Standard	ISO/IEC 8802-03 1000BASE-SX/LX
		Connection type	1 Gigabit Ethernet SFP transceiver

Table 7: Combo ports: Connection options

When you are using an SFP transceiver, you get an optical interface. You thus deactivate the corresponding TP interface.

1.10 Display elements

After the operating voltage is set up, the software starts and initializes itself. Afterwards, the device performs a self-test. During this process, various LEDs light up. The process takes around 60 seconds.

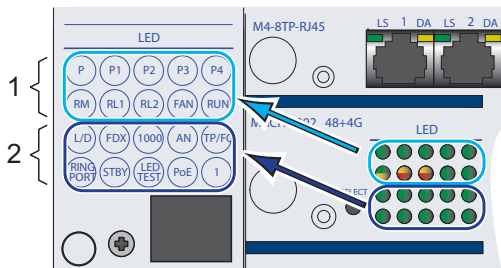

Figure 20: Display elements for device state and port display state

1 - Device state

2 - Port display state

1.10.1 Device state

These LEDs provide information about conditions which affect the operation of the whole device.

LED	Display	Color	Activity	Meaning
P	Power supply	Green	Lights up	The supply voltage is on.
			None	The supply voltage is too low.
LED	Display	Color	Activity	Meaning
P1	Power supply	Green	Lights up	Supply voltage 1 is present at the plug-in power unit.
			None	No supply voltage 1, or voltage too low, at the plug-in power unit.
		Green	flashing	Supply voltage 1 is present, but the plug-in power unit is reporting an error.
LED	Display	Color	Activity	Meaning
P2	Power supply	Green	Lights up	Supply voltage 2 is present at the plug-in power unit.
			None	No supply voltage 2, or voltage too low, at the plug-in power unit.
		Green	flashing	Supply voltage 2 is present, but the plug-in power unit is reporting an error.
LED	Display	Color	Activity	Meaning
P3	Power supply	Green	Lights up	Supply voltage 3 is present at external input 3.
			None	No supply voltage 3, or voltage too low, at external input 3
		Green	flashing	Supply voltage 3 is present, but the plug-in power unit is reporting an error.
LED	Display	Color	Activity	Meaning
P4	Power supply	Green	Lights up	Supply voltage 4 is present at external input 4.
			None	No supply voltage 4, or voltage too low, at external input 4
		Green	flashing	Supply voltage 4 is present, but the plug-in power unit is reporting an error.
LED	Display	Color	Activity	Meaning
RM	Ring Manager	Green	Lights up	The RM function is active. The redundant port is disabled.
		Yellow	Lights up	The RM function is active. The redundant port is enabled.
			None	The RM function is deactivated.
		Green	flashing	The device detects an incorrect configuration of the HIPER-Ring (e.g. the ring is not connected to the ring port).
LED	Display	Color	Activity	Meaning
RL1	Signal contact (Relay 1)	Red	Lights up	Signal contact 1 is open; it is reporting an error.
		Yellow	Lights up	Signal contact 1 is open. The "Manual setting" is active.
			None	Signal contact 1 is closed, it is not reporting an error, or it was closed via the "Manual setting".

LED	Display	Color	Activity	Meaning
RL2	Signal contact (Relay 2)	Red	Lights up	Signal contact 2 is open; it is reporting an error.
		Yellow	Lights up	Signal contact 2 is open. The "Manual setting" is active.
			None	Signal contact 2 is closed, it is not reporting an error, or it was closed via the "Manual setting".
LED	Display	Color	Activity	Meaning
FAN	Fan	Green	Lights up	The plug-in fan unit is installed, and no fan is reporting an error.
			None	The plug-in fan unit is installed and at least one fan is reporting an error, or the plug-in fan unit is not installed.
LED	Display	Color	Activity	Meaning
RUN	BOOT/ RUN	Green	Lights up	The system is operational.
		Green	Lights up	The system is booting.
			None	The system is in reset mode.

1.10.2 Port status display

Every media module has one LED per port. The meaning of this port status LED depends on the setting on the basic device. You define the display meaning with the "SELECT" button on the basic device.

- Press the button for approx. 2 seconds to change the meaning of the display. If the button is not pressed for approx. 20 seconds, the display status changes back to "L/D".

LED	Display	Color	Activity	Meaning
L/D	Link status	Green	Lights up	The port LEDs of the media modules display the connection status.
LED	Display	Color	Activity	Meaning
FDX	Full duplex/ half duplex	Green	Lights up	The port LEDs of the media modules display the half-duplex or full-duplex connection status.
LED	Display	Color	Activity	Meaning
1000	10/100/1000 Mbit/s	Green	Lights up	The port LEDs of the media modules display the set transmission speed.
LED	Display	Color	Activity	Meaning
ON	Auto-negotiation	Green	Lights up	The port LEDs of the media modules display the port configuration type.
LED	Display	Color	Activity	Meaning
RING PORT	Ring port	Green	Lights up	The port LEDs of the media modules display the HIPER-Ring assignment.
LED	Display	Color	Activity	Meaning
STBY	Stand-by	Green	Lights up	The port LEDs of the media modules display the assignment to a redundant coupling of network segments.

LED	Display	Color	Activity	Meaning
LED TEST	Light emitting diode test	Green	Lights up	The status, display status and port status LED test is active. The “RM” LED status flashes green/yellow. The “FAULT” LED status flashes red. The display status LEDs flash green. The port status LEDs of the media modules flash green/yellow.
LED	Display	Color	Activity	Meaning
TP/FO	Twisted pair Fiber optic	Green	Lights up	The port LEDs of the media modules display the media type.
LED	Display	Color	Activity	Meaning
All display status LEDs	Initialization	Green	Running light	The initialization phase is running after a restart.
LED	Display	Color	Activity	Meaning
1		Green		Service LED
LED	Display	Color	Activity	Meaning
2	PoE status	Green	Lights up	The port LEDs of the media modules display the PoE (Power over Ethernet) status.

1.10.3 ACA auto configuration adapter

LED	Display	Color	Activity	Meaning
RUN and 1	ACA memory operation	Green	Flashing alternately	Error in the memory operation
		Green	flash synchronously – 2 x per period	Save a configuration file from the ACA to the device.
		Green	flash synchronously – 1 x per period	Saving a configuration file from the device to the ACA.

Port state

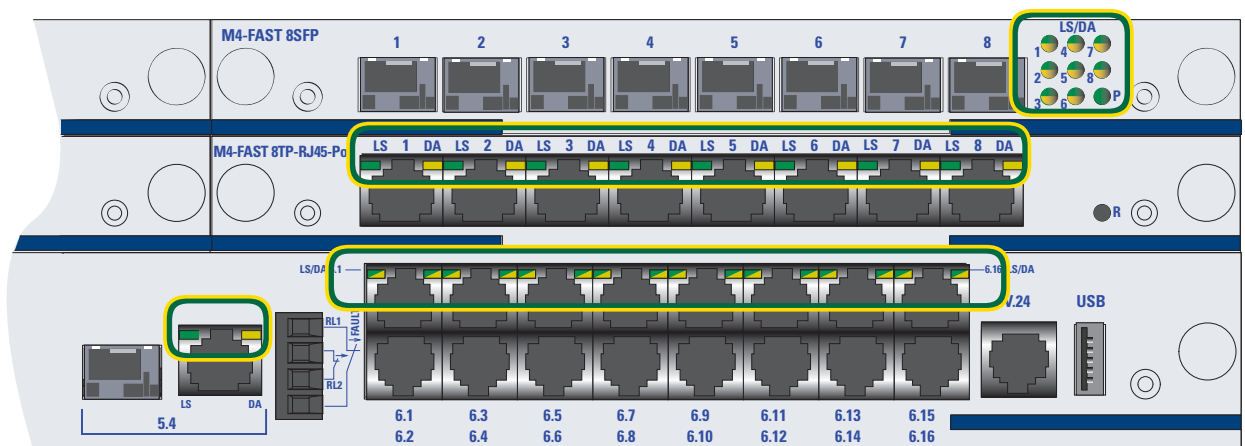

These LEDs display port-related information. For each port, the following are available:

- ▶ Two one-color LEDs
- ▶ One two-color LED

You set the content of the information with the button on the chassis.

See “Port status display” on page 34.

LED	Display	Color	Activity	Meaning
1 ... n	Link status		None	The device detects an invalid or missing connection.
		Green	Lights up	The device detects a valid connection.
		Green	Flashes 1 time a period	The port is switched to stand-by.
		Green	Flashes 3 times a period	The port is disabled.
	Data traffic	Yellow	Flashing	The device is sending and/or receiving data.
LED	Display	Color	Activity	Meaning
1 ... n	FDX		None	The half-duplex connection type is active
		Green	Lights up	The full-duplex connection type is active
LED	Display	Color	Activity	Meaning
1 ... n	Transmission speed		None	Transmission speed 10 Mbit/s is active.
		Green	Lights up	Transmission speed 100 Mbit/s is active.
		Yellow	Lights up	Transmission speed 1000 Mbit/s is active.
		green/yellow	flashing	Transmission speed 10000 Mbit/s is active.
LED	Display	Color	Activity	Meaning
1 ... n	Auto-negotiation	Green	Lights up	Autonegotiation is active.
LED	Display	Color	Activity	Meaning
1 ... n	Twisted pair Fiber optic		None	Autoselect, no medium has been selected.
		Green	Lights up	Twisted pair has been selected. The port LEDs of the media modules display the twisted pair ports.
		Yellow	Lights up	Fiber optic has been selected. The port LEDs of the media modules display the F/O ports.
LED	Display	Color	Activity	Meaning
1 ... n	RING PORT	Green	Lights up	This port is assigned to the HIPER-Ring.
LED	Display	Color	Activity	Meaning
1 ... n	Stand-by	Green	Lights up	Connection port for the data line.
		Yellow	Lights up	Connection port for the control line.
		green/yellow	flashing	No stand-by partner available.
LED	Display	Color	Activity	Meaning
1 ... n	LED TEST	Green	Lights up	The LED is not operating.
		green/yellow	flashing	The LED test is active.

LED	Display	Color	Activity	Meaning
1 ... n	PoE		None	No PoE port available or: Power over Ethernet function is disabled (PoE port status = disabled).
		Green	Lights up	A PoE terminal device is registered and is receiving power via PoE.
		Yellow	Lights up	The Power over Ethernet function is enabled, but no voltage is supplied via PoE.

1.11 Management interfaces

1.11.1 V.24 interface (external management)

The V.24 interface is an RJ11 socket.

The V.24 interface is a serial interface which allows you to connect the following devices locally:

- ▶ An external management station (VT100 terminal or PC with appropriate terminal emulation). This enables you to set up a connection to the Command Line Interface (CLI) and to the system monitor.
- ▶ An AutoConfiguration Adapter ACA 11

VT 100 terminal settings

Speed	9,600 Baud
Data	8 bit
Stopbit	1 bit
Handshake	off
Parity	none

The socket housing is electrically connected to the front panel of the device. The V.24 interface is not electrically isolated from the supply voltage.

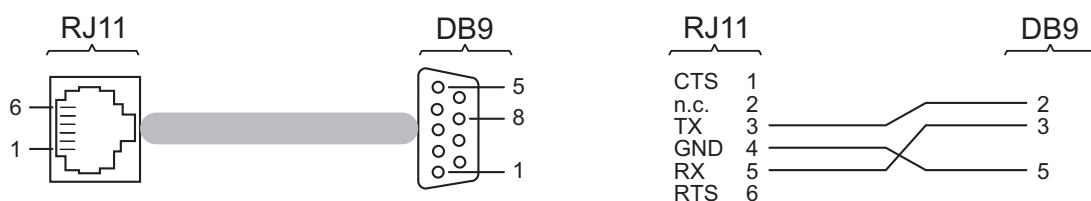

Figure 21: Pin assignment of the V.24 interface and the DB9 connector

Note: You will find the order number for the terminal cable, which is ordered separately, in the Technical Data chapter ([see on page 55 “Technical data”](#)).

1.11.2 USB interface

The USB socket provides an interface for the local connection of an AutoConfiguration Adapter. It is used for saving/loading the configuration and for loading the software.

See “Accessories” on page 63.

Figure	Pin	Operation
	1	VCC (VBus)
	2	- Data
	3	+ Data
	4	Ground (GND)

Table 8: Pin assignment of the USB interface

2 Installation

On delivery, the device is ready for operation.

The following procedure has been proven to be successful for the assembly of the device:

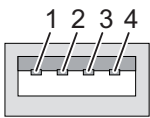
- ▶ Unpacking and checking
- ▶ Installing the device and grounding
- ▶ Mounting the power supply unit on the back of the MACH4000 device
- ▶ Installing the M4-AIR... plug-in fan unit
- ▶ Installing the plug-in power units in the M4-POWER power unit chassis
- ▶ Installing the media modules
- ▶ Installing SFP/XFP transceivers (optional)
- ▶ Connecting the supply voltage, starting up
- ▶ Wiring and assembling the signal contact
- ▶ Connecting the data lines

Note: Read the safety guidelines under “Safety instructions” on page 5.

2.1 Unpacking and checking

- Check whether the package includes all items named in section “Scope of delivery” on page 61.
- Check the individual parts for transport damage.

2.2 Installing the device and grounding

You have the option of assembling the device on a flat surface or in a 19" standard switch cabinet.

2.2.1 Selecting the assembly location



CAUTION

OVERHEATING OF THE DEVICE

When installing the device, ensure that the ventilation slots are not covered.

Failure to follow these instructions can result in injury or equipment damage.

Select the assembly location according to the safety guidelines ([see on page 5 “Safety instructions”](#)).

When selecting the assembly location, also make sure the following requirements are met:

- ▶ The assembly location can be accessed for maintenance and repair work.
- ▶ The LED display elements are clearly visible.
- ▶ Twisted-pair cables are at a sufficient distance from potential sources of electrical interference, such as power cables.
- ▶ The device has a separate power source with a ground connection. The power supply can be interrupted by means of a separate isolator or power switch. We recommend using overvoltage protection for all devices.

Note: The shielding ground of the connectable industrial twisted pair lines is connected to the front panel as a conductor.

2.2.2 Mounting on a flat surface

Before operating the device on a flat surface, such as a table, fasten the housing feet supplied at a distance of 2 cm from the corners of the bottom of the device.

- If necessary, remove any dirt from the adhesive surfaces on the bottom of the device.
- Remove the protective foil from the adhesive surface of a housing foot and attach the housing foot.

2.2.3 Mounting in a switch cabinet

The devices are designed to be mounted in a 19" switch cabinet. By mounting your MACH4000 device in a 19" switch cabinet on sliding/mounting rails, you provide a more stable position for your device in environments subject to vibration.

Note: For more information on sliding/mounting rails and how to install them, please contact your switch cabinet manufacturer.

If you are operating the device in a 19" switch cabinet, you must install sliding/mounting rails (not included in the delivery) to hold the weight of the device.

NOTE

VIBRATIONS

Assemble the device in a 19" switch cabinet on sliding/mounting rails.

Non-adherence to these instructions can lead to material damage.

- Make sure there is sufficient ventilation. If necessary, provide a fan for the 19" switch cabinet. This will prevent the basic devices from overheating.
- Measure the depth of the 19" switch cabinet so as to allow the power supply cables to be fitted at the back and the data cables to be fitted at the front.
- Install the sliding/mounting rails in the 19" switch cabinet as instructed by the manufacturer, and make sure the device is resting on both rails.

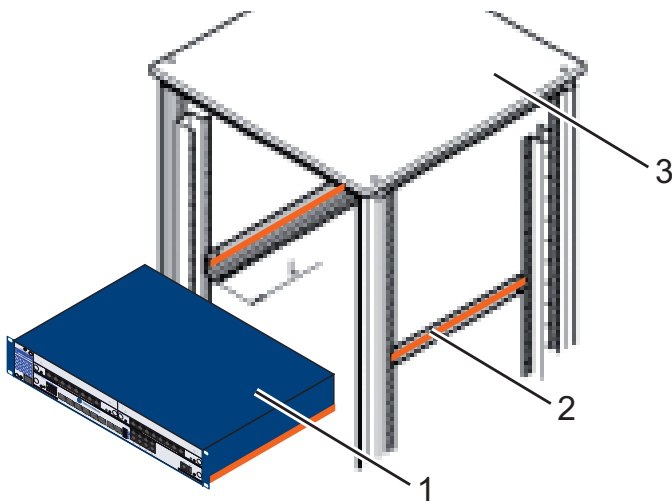

Figure 22: Assembly in a switch cabinet with sliding/mounting rails

- 1 - MACH4000 device*
- 2 - Sliding/mounting rail*
- 3 - 19" switching cabinet*

On delivery, two brackets are attached to the sides of the device (see figure below).



- Fasten the device by screwing the brackets to the switch cabinet.

2.2.4 Grounding

The device is grounded via the power supply connections.

Note: The shielding ground of the connectable twisted pairs lines is connected to the front panel as a conductor. When the device is being operated via the 230/120 V AC power supply unit, it is grounded via the safety plug. When it is being operated with external DC voltage via the M4-POWER connections, the device is grounded via the M4-POWER connection.

2.3 Mounting the power supply unit on the back of the MACH4000 device



- Remove the cover panel.
- Slide the power supply unit all the way into the basic device along the mounting rails above and below.
- Make sure that there is a good connection between the multiple plug of the plug-in power unit and the female multipoint of the system bus.
- Screw the four slotted-head screws in the front panel of the plug-in power unit flush with the frame of the basic device.

2.4 Mounting the power unit chassis, connecting with the MACH4000 device

NOTE

SHORT-CIRCUIT

Insert the plugs of the power supply cables in straight in order to avoid the bridging of pins on the power supply connection of the MACH4000 device.

Non-adherence to these instructions can lead to material damage.

Note: The power supply cables between the M4-POWER power unit chassis and the MACH4000 device are not hot-swappable.

Note: The power supply cables between the M4-POWER power unit chassis and the MACH4000 device carry system-internal safety extra-low voltages. Only use the M4-POWER CABLE and the M4-POWER power unit chassis for the redundant power supply. Do not connect any other external voltage source.

Consider the sequence for the cabling of the power unit chassis and the MACH4000 device:

- Separate the external power supply from the M4-POWER power unit chassis.
- Remove all the plug-in power units from the M4-POWER power unit chassis.
- Connect one end of the M4-POWER CABLE to the MACH4000 device.
- Connect the other end of the M4-POWER CABLE to the M4-POWER power unit chassis.
- Connect the MACH4000 device and the M4-POWER power unit chassis with the mounting bracket included in the delivery.
- Slot all the plug-in power units into the M4-POWER power unit chassis.
- Connect the external power supply (AC or DC, depending on the plug-in power unit) with the M4-POWER power unit chassis.

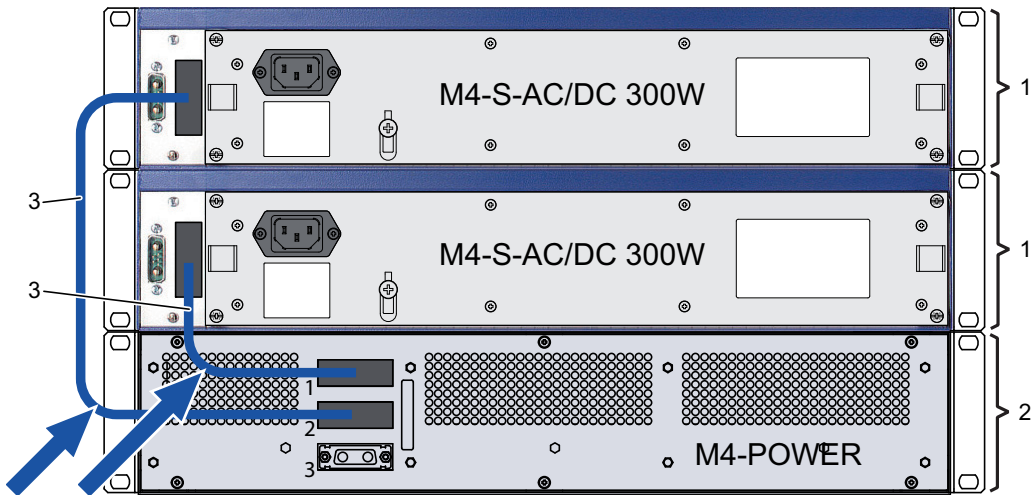

Figure 23: Redundant power supply via the M4-POWER power unit chassis.
 Step 1: Connect MACH4000 device(s) to M4-POWER
 1 - MACH4000, back
 2 - M4-POWER power unit chassis, back
 3 - Not hot-swappable

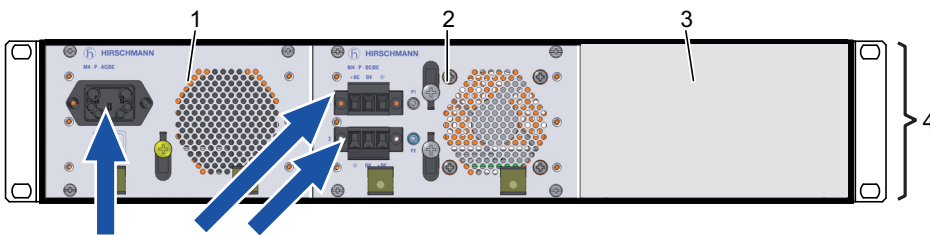

Figure 24: Redundant power supply via the M4-POWER power unit chassis.
 Step 2: Connecting M4-POWER to the power supply (example: configuration with 2 plug-in power units)
 1 - Plug-in power unit 1
 2 - Plug-in power unit 2
 3 - Not used
 4 - M4-POWER power unit chassis, front of device

2.5 Installing the M4-AIR... plug-in fan unit

- Slide the new plug-in fan unit all the way into the basic device along the mounting rails above and below.
- Make sure that there is a good connection between the multiple plug of the plug-in fan unit and the female multipoint of the system bus.
- Screw the two knurled screws in the front panel of the plug-in fan unit with the frame of the basic device.

2.6 Installing the plug-in power units in the M4-POWER power unit chassis



When replacing a defective plug-in power unit, only use a plug-in power unit of the M4-P-... 300W type ([see on page 61 “Order numbers/product description”](#))

- Remove the power supply cables.
- Loosen the four screws used to fasten the plug-in power unit in the basic device and pull the unit out of the basic device, or remove the cover plate of the power unit slot.
- Slide the new plug-in power unit all the way into the basic device along the mounting rails above and below.
- Make sure that there is a good connection between the multiple plug of the plug-in power unit and the female multipoint of the system bus.
- Screw the slotted-head screws in the front panel of the plug-in power unit flush with the frame of the basic device.
- Connect the power supply cables.

Note: The tightening torque is

- ▶ 7 lb in. (0.791 Nm) for input connections.
- ▶ 11 lb in. (1.243 Nm) for all field wiring terminal blocks.

2.7 Installing the media modules

The switch has four inputs for connecting media modules.

The number of connectable network segments depends on the number of media modules installed. If the full four media modules with 8 ports each are connected, then in addition to the ports of the basic board, you get a further 32 ports for connecting network segments.

The modular design of the device allows you to easily expand the network yourself by installing the desired media modules.

The media modules can be installed in the devices, or deinstalled, while the network is operating (hot-swappable).

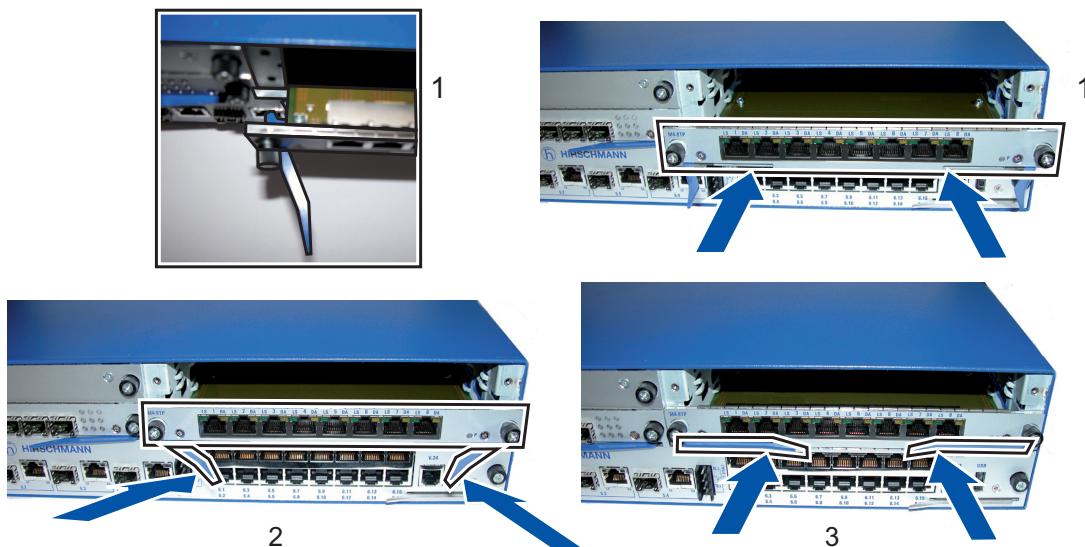

Figure 25: Installing the media modules

1 - Step 1

2 - Step 2

3 - Step 3

Note: Note the ESD guidelines on (see on page 8) and the safety instructions on (see on page 5).

- Close the whole of the front surface beside the media modules with cover panels. This provides optimal shielding and convection. The slots for the media modules are all the same. They can be selected in any order.
- Remove the cover panel to insert the media module.
- Note the positions of the blue insertion catches (see Fig. above, step 1)
- Insert the media module almost as far as it will go into the desired slot (see Fig. above, step 2).
- Make sure that there is a good connection between the multiple plugs of the media module and the female multipoints of the system bus.

- Insert the media module as far as it will go into the desired slot by closing the blue insertion catches. (See Fig. above, step 3).
- Screw the two knurled screws in the front panel of the media module flush with the frame of the basic device.

2.8 Installing SFP/XFP transceivers (optional)

Note: You will find further information under “SFP/XFP transceiver” on page 29.

Note: Only use Hirschmann SFP/XFP transceivers.
See “Accessories” on page 63.

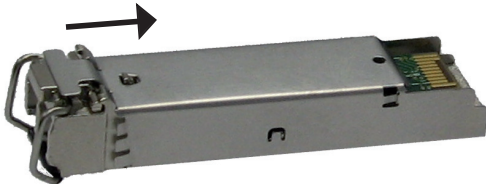

Figure 26: F/O SFP transceiver

- Before attaching an SFP or XFP transceiver, first remove the protective cap of the SFP/XFP transceiver.
- Push the SFP/XFP transceiver with the lock closed into the socket until it latches audibly in place.

2.9 Connecting the supply voltage, starting up

WARNING

ELECTRIC SHOCK

Only start connecting the supply voltage if **all** the above requirements are fulfilled.

See “Supply voltage” on page 5.

Failure to follow these instructions can result in death, serious injury, or equipment damage.

Remarks:

- ▶ Observe the information about the voltages to be connected: “[Technical data](#)” on page 55
- ▶ For the AC input of the AC/DC plug-in power units, use a nominal rating of not more than 16 A - slow-blow characteristic.

- ▶ For the DC input of the DC plug-in power units at P1 and P2, use a nominal rating of not more than 20 A - slow-blow characteristic.
- ▶ Do not use a redundant power supply at P1 and P2 simultaneously if one of the “+” connections of P1 or P2 is grounded.
- ▶ For the redundant power supply, only use voltage sources whose negative terminal is grounded.
- ▶ For the current conductors at the voltage input of the DC plug-in power units, use a cable cross-section of at least 2.5 mm² (North America: AWG12).
- ▶ For the current conductors at the voltage input of the AC/DC plug-in power units, use a cable cross-section of at least 1.0 mm² (North America: AWG16).

⚠ **WARNING**

This applies exclusively to device variants with a DC power supply:

FIRE HAZARD

Install a back-up fuse in both of the input voltage conductors if the negative terminal of the voltage source power is not grounded.

Use a back-up fuse suitable for DC.

Failure to follow these instructions can result in death, serious injury, or equipment damage.

- Connect the power supply cable to the power input.
- Install strain relief.
- Switch on the plug-in power units to start up the device.

2.10 Wiring and assembling the signal contact

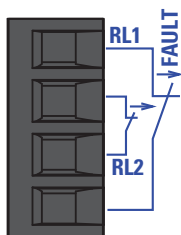

Figure 27: 4-pin signal contact

The potential-free signal contact (relay contact, closed circuit) reports through a break in contact:

- ▶ The failure of at least one supply voltage.
- ▶ The device is not operational.
- ▶ The failure of the connection on at least one port.
The report of the link status can be masked by the Management for each port. In the delivery state, is deactivated.
- ▶ Failure of the ring redundancy reserve.
- ▶ Errors detected during the self-diagnostic test.

The following conditions are reported in standby mode:

- ▶ Control cable interrupted
- ▶ Control cable short-circuited
- ▶ Partner device is in standby mode

The following conditions are reported in normal mode:

- ▶ Control cable short-circuited
- ▶ Partner device is in normal mode

The following condition is also reported in RM mode:

- ▶ Ring redundancy reserve is available. On delivery, there is no ring redundancy monitoring.

- Pull the terminal block off the Switch and connect the signal lines.
- Mount the terminal block for the two signal contacts on the front of the device. Make sure that the snap lock snaps into place.

Note: The tightening torque for fixing the signal contact terminal block to the device is 3 lb in (0.34 Nm).

You can also use the Management to switch the signal contact manually and thus control external devices.

2.11 Connecting the data lines

You can connect terminal devices and other segments on the ports of the device via twisted pair cables or F/O cables.

Note: Make sure that you only connect optical ports of the same type with each other, e.g. single-mode ports with single-mode ports.

- Install the data lines according to your requirements.

You will find further information under [“Ethernet ports” on page 30](#).

3 Basic set-up

WARNING

UNINTENTIONAL OPERATION IN DEVICE

Install and maintain a process that assigns a unique IP address to every device in the network.

Failure to follow these instructions can result in death, serious injury, or equipment damage.

The IP parameters must be entered when the device is installed for the first time. The device provides 6 options for configuring IP addresses:

- ▶ Entry via V.24 connection
- ▶ Entry using the HiDiscovery protocol via the application HiDiscovery or Industrial HiVision
- ▶ Configuration via BOOTP
- ▶ Configuration via DHCP
- ▶ Configuration via DHCP Option 82
- ▶ Auto Configuration Adapter

Further information on the basic settings of the device can be found in the “Basic Configuration” user manual on the CD/DVD.

■ **Default settings**

- ▶ IP address: The device looks for the IP address using DHCP
- ▶ Password for management:
Login: user; password: public (read only)
Login: admin; password: private (read and write)
- ▶ V.24 data rate: 9,600 Baud
- ▶ Ring redundancy: disabled
- ▶ Ethernet ports: link status is not evaluated (signal contact)
- ▶ Optical 100 Mbit/s ports: 100 Mbit/s, full duplex
Optical 10 Gbit/s ports: 10 Gbit/s, full duplex
All other ports: autonegotiation
- ▶ Ring manager disabled
- ▶ Stand-by coupling: disabled

4 Maintenance and service

- When designing this device, Hirschmann was largely able to forego using parts that are subject to wear and tear. The parts subject to wear are designed to last longer than the lifetime of the product when it is operated properly. Operate this device according to the specifications (see [“Technical data”](#)).
- Relays are subject to natural wear. This wear depends on the frequency of the switching operations. Check the resistance of the closed relay contacts and the switching function depending on the frequency of the switching operations.
- Hirschmann is continually working to improve and develop our software. You should regularly check whether there is a new version of the software that provides you with additional benefits. You will find software information and downloads on the product pages of the Hirschmann website.
- Depending on the degree of pollution in the operating environment, check at regular intervals that the ventilation slots in the device are not obstructed.

Note: You will find information about the complaints and returns procedures in the Internet under <http://www.beldensolutions.com/en/Service/Repairs/index.phtml> .

5 Deinstallation

5.1 Deinstalling the media modules

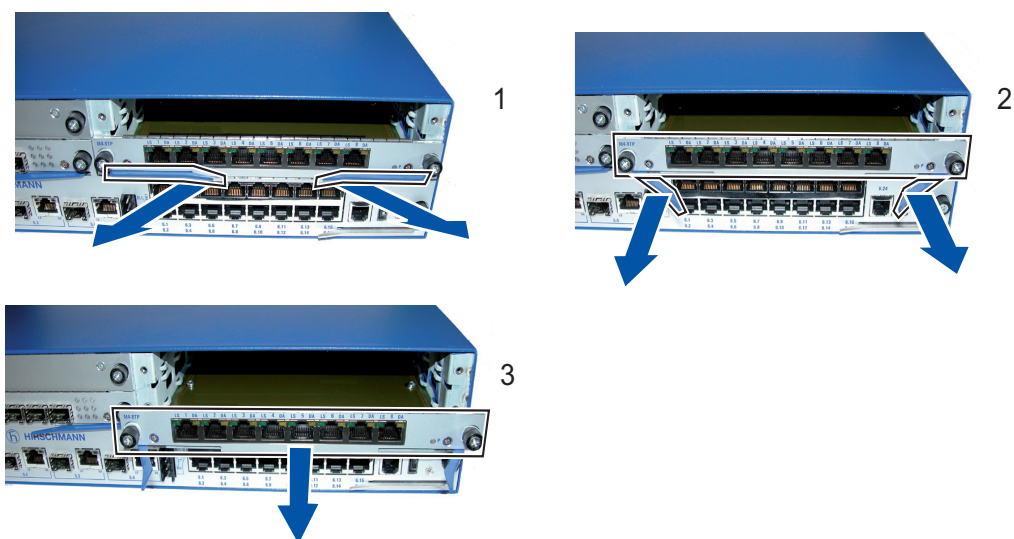

Figure 28: Deinstalling the media modules

- 1 - Step 1
- 2 - Step 2
- 3 - Step 3

Note: Note the ESD guidelines on (see on page 8) and the safety instructions on (see on page 5).

- Lever the selected media module from the slot by pulling the blue insertion catches (see Fig. above, steps 1 and 2).
- Pull the media module out of the slot (see Fig. above, step 3).
- Close the slot with a cover panel.
- Screw the four knurled screws in the cover panel flush with the frame of the basic device.

5.2 Deinstalling the SFP/XFP transceivers

- Pull the SFP/XFP transceiver out of the socket using the opened lock.
- Close the SFP/XFP transceiver with the protective cap.

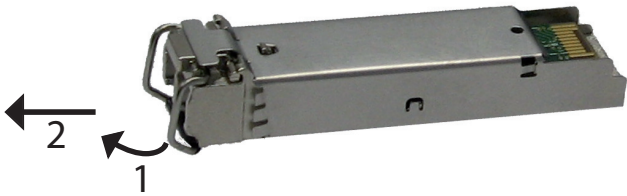

Figure 29: Deinstalling an SFP transceiver

5.3 Deinstalling the M4-AIR... plug-in fan unit

CAUTION

ROTATING PARTS

After the device is switched off, the fan blades continue rotating for a number of seconds. Do not reach into a rotating fan!

Failure to follow these instructions can result in injury or equipment damage.

- Remove the two screws in the front panel of the M4-AIR or M4-AIR-L plug-in fan unit.
- Pull the plug-in fan unit out a few centimeters and wait until the fan comes to a halt before pulling it all the way out.

6 Technical data

■ General technical data

Dimensions	MACH4002-... M4-POWER	W x H x D: 480 mm × 88 mm × 435 mm W x H x D: 480 mm × 88 mm × 435 mm
Assembly	MACH4002-... M4-POWER	19" switch cabinet 19" switch cabinet
Weight	MACH4002-...	7.5 kg
Power supply	MACH4002-...	M4-S-xx power supply unit or power unit chassis M4-POWER with M4-P-xx power supply unit please order separately
Operating voltage	M4-S-AC/DC 300W M4-S-24VDC 300W M4-S-48VDC 300W	Nominal voltage AC: 100 ... 240 V, 50 ... 60 Hz Voltage range AC: 90 ... 265 V, 47 ... 63 Hz 24 V DC (19.2 V ... 32 V) ^a 48 V DC (38.4 V ... 60 V) ^a
	M4-P-AC/DC 300W M4-P-24VDC 300W M4-P-48VDC 300W	Nominal voltage AC: 100 ... 240 V, 50 ... 60 Hz Voltage range AC: 90 ... 265 V, 47 ... 63 Hz 24 V DC (19.2 V ... 32 V) ^a 48 V DC (38.4 V ... 60 V) ^a
Buffer time	M4-P-AC/DC 300W M4-...-24VDC 300W M4-...-48VDC 300W	min. 1/2 mains period min. 10 ms at 20.4 V DC min. 10 ms at 40.8 V DC
Current consumption	M4-S-AC/DC 300W M4-S-24VDC 300W M4-S-48VDC 300W	max. 1.7 A (240 V AC), max. 4.0 A (100 V AC) max. 16.0 A (24 V DC), max. 20.0 A (19.2 ... 32 V DC) max. 8.0 A (48 V DC), max. 10 A (38.4 ... 60 V DC)
	M4-P-AC/DC 300W M4-P-24VDC 300W M4-P-48VDC 300W	max. 1.7 A (240 V AC), max. 4.0 A (100 V AC) max. 16.0 A (24 V DC), max. 20.0 A (19.2 ... 32 V DC) max. 8.0 A (48 V DC), max. 10.0 A (38.4 ... 60 V DC)
Activation current	M4-S-AC/DC 300W M4-P-AC/DC 300W	typ. <40.0 A at 265 V AC and cold start typ. <40.0 A at 265 V AC and cold start
Overload current protection at input		Non-replaceable fuse
Potential difference between incoming voltage and housing	M4-...-...VDC 300W	Potential difference from incoming voltage +24 V DC/ +48 V DC: 60 V DC Potential difference from incoming voltage 0 V: 60 V DC ^b
"FAULT" signal contact	Switching current Switching voltage Insulation voltage	max. 1 A, SELV max. 60 V DC or max. 30 V AC, SELV to front panel, power supply, other inputs/outputs: max. 1,500 V DC
Environment	Storage temperature Humidity Air pressure	Ambient air: -25 °C ... +70 °C 10 % ... 95 % (non condensing) Up to 2000 m (795 hPa), higher altitudes on request

Operating temperature	MACH4002-...	With M4-AIR plug-in fan unit: Ambient air: 0 °C ... +60 °C
	M4-S-xx, M4-P-xx	
	M-SFP-xx/xx	With M4-AIR-L plug-in fan unit: Ambient air: 0 °C ... +40 °C
	M-XFP-xx/xx	
	M-FAST SFP-xx/xx	
	M4-8TP-RJ45	
	M4-8TP-RJ45 PoE	
M4-FAST 8-SFP		
M4-GIGA 8-SFP		
Pollution degree		2
Protection classes	Laser protection Protection class	Class 1 according to EN 60825-1 (2001) IP 20

- a. NEC Class 2 power source safety extra-low voltage (SELV/PELV)
- b. The 0 V connections within a DC module (M4-...-...VDC 300W) are connected with each other.

■ Dimension drawings

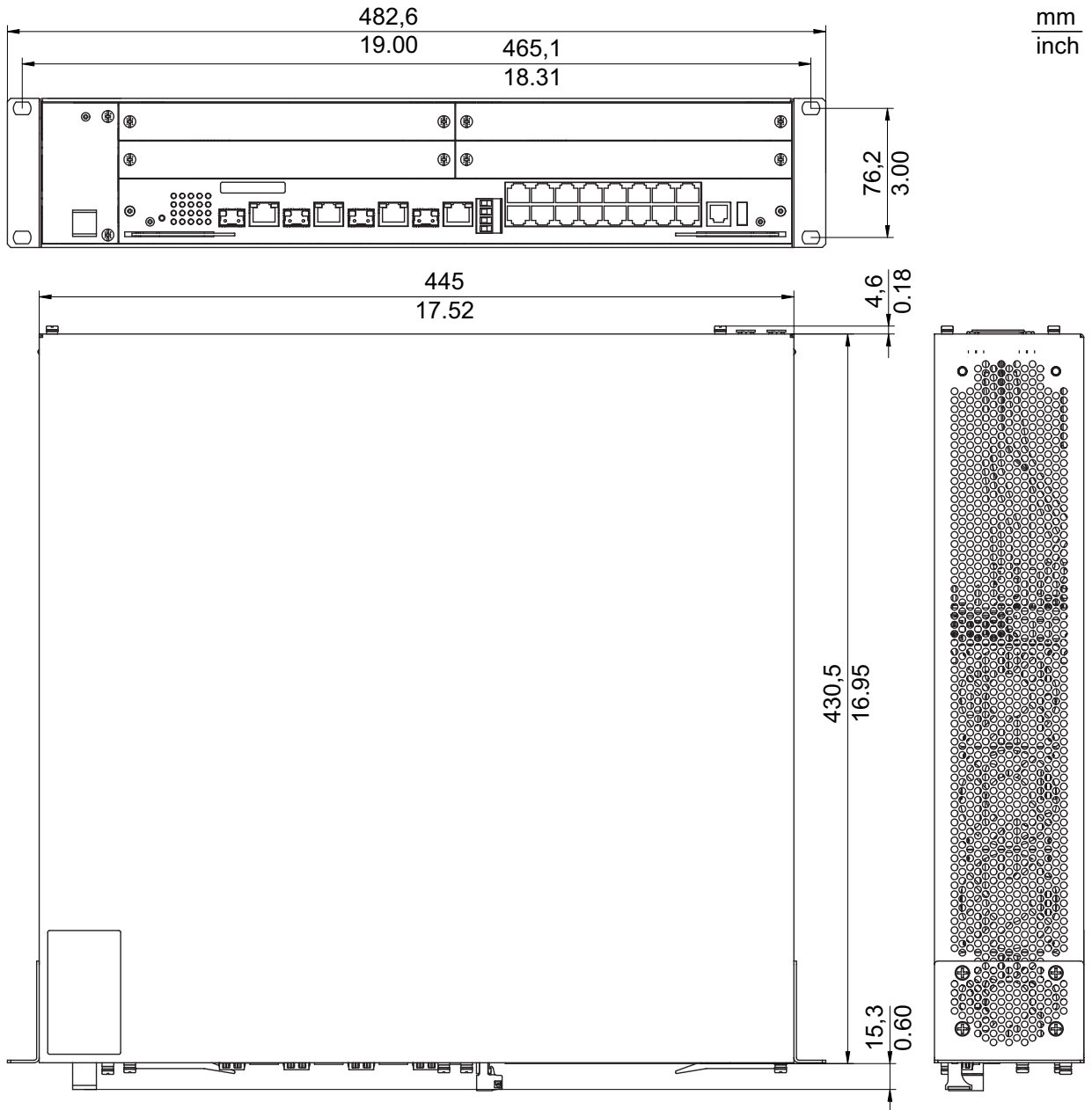

Figure 30: Dimensions

■ Interfaces

	Interface	Design
MACH4002-...	Signal contact	4-pin pluggable terminal block
	V.24 access	1 x RJ11 socket
	USB interface	For connecting an AutoConfiguration Adapter ACA 21-USB

■ EMC and immunity

EMC interference immunity		
IEC/EN 61000-4-2	Electrostatic discharge Contact discharge Air discharge	6 kV 8 kV
IEC/EN 61000-4-3	Electromagnetic field 80 - 2,700 MHz	10 V/m
IEC/EN 61000-4-4	Fast transients (burst) - Power line - Data line	2 kV 4 kV
IEC/EN 61000-4-5	Voltage surges - Power line, line/line: - Power line, line/earth - Data line	2 kV 2 kV 4 kV
IEC/EN 61000-4-6	Line-conducted interference voltages 150 kHz - 80 MHz	10 V
EN 61000-4-9	Pulse magnetic fields	300 A/m
EMC interference emission		
EN 55022	Class A	Yes
FCC 47 CFR Part 15	Class A	Yes
German Lloyd	Classification + Construction Guidelines VI-7-3 Part 1 Ed.2001	Yes
Stability		
Vibration	IEC 60068-2-6 Test FC test level according to IEC 61131-2	Yes
	Germanischer Lloyd Guidelines for the Performance of Type Tests Part 1	Yes
Shock	IEC 60068-2-27 Test Ea test level according to IEC 61131-2	Yes

■ Network range

TP port	
Length of a twisted pair segment	max. 100 m (cat5e cable with 1000BASE-T)

Table 9: TP port 10BASE-T / 100BASE-TX / 1000BASE-T

Product code	Wave length	Fiber	System attenuation	Example for F/O line length	Fiber data	BLP/ dispersion
M-FAST-SFP-...						
-MM/LC...	MM	1310 nm	50/125 µm	0-8 dB	0-5 km	1.0 dB/km 800 MHz×km
-MM/LC...	MM	1310 nm	62.5/125 µm	0-11 dB	0-4 km	1.0 dB/km 500 MHz×km
-SM/LC...	SM	1310 nm	9/125 µm	0-13 dB	0-25 km	0.4 dB/km 3.5 ps/(nm×km)

Table 10: Fiber port 100BASE-FX (SFP fiber optic Fast Ethernet Transceiver)

Product code M-FAST-SFP-...	Wave length	Fiber	System attenuation	Example for F/O line length	Fiber data	BLP/dispersion
-SM+/LC...	SM 1310 nm	9/125 μm	10-29 dB	25-65 km	0.4 dB/km	3.5 ps/(nm*km)
-LH/LC...	SM 1550 nm	9/125 μm	10-29 dB	47-104 km	0.25 dB/km	19 ps/(nm*km)

Table 10: Fiber port 100BASE-FX (SFP fiber optic Fast Ethernet Transceiver)

Product code M-SFP-...	Wave length	Fiber	System attenuation	Example for F/O line length	Fiber data	BLP/dispersion
-SX/LC...	MM 850 nm	50/125 μm	0-7.5 dB	0-550 m	3.0 dB/km	400 MHz*km
-SX/LC...	MM 850 nm	62.5/125 μm	0-7.5 dB	0-275 m	3.2 dB/km	200 MHz*km
-MX/LC	MM 1310 nm	50/125 μm	0-8 dB	2 km ^a	1.0 dB/km	500 MHz*km
-MX/LC	MM 1310 nm	62.5/125 μm	0-8 dB	1 km	1.0 dB/km	500 MHz*km
-LX/LC...	MM 1310 nm ^b	50/125 μm	0-10.5 dB	0-550 m	1.0 dB/km	800 MHz*km
-LX/LC...	MM 1310 nm ^d	62.5/125 μm	0-10.5 dB	0-550 m	1.0 dB/km	500 MHz*km
-LX/LC...	SM 1310 nm	9/125 μm	0-10.5 dB	0-20 km ^c	0.4 dB/km	3.5 ps/(nm*km)
-LX+/LC...	SM 1310 nm	9/125 μm	5-20 dB	14-42 km	0.4 dB/km	3.5 ps/(nm*km)
-LH/LC...	LH 1550 nm	9/125 μm	5-22 dB	23-80 km	0.25 dB/km	19 ps/(nm*km)
-LH+/LC	LH 1550 nm	9/125 μm	15-30 dB	71-108 km	0.25 dB/km	19 ps/(nm*km)
-LH+/LC	LH 1550 nm	9/125 μm	15-30 dB	71-128 km	0.21 dB/km	19 ps/(nm*km) (typically)

Table 11: Fiber port 1000BASE-FX (SFP fiber optic Gigabit Ethernet Transceiver)

- a. Distances of up to 3 km reachable, 1000 MHz*km (1300 nm)
- b. With F/O adapter compliant with IEEE 802.3-2002 clause 38 (single-mode fiber offset-launch mode conditioning patch cord)
- c. including 2.5 dB system reserve when compliance with the fiber data is observed

Product code M-XFP-...	Wave length	Fiber	System attenuation	Example for F/O line length	Fiber data	BLP/dispersion
-SR/LC	MM 850 nm	62.5/125 μm	0-8.1 dB	max. 26 m	3.2 dB/km	160 MHz*km
-SR/LC	MM 850 nm	62.5/125 μm	0-8.1 dB	max. 33 m	3.2 dB/km	200 MHz*km
-SR/LC	MM 850 nm	50/125 μm	0-8.1 dB	max. 66 m	3.0 dB/km	400 MHz*km
-SR/LC	MM 850 nm	50/125 μm	0-8.1 dB	max. 82 m	3.0 dB/km	500 MHz*km
-SR/LC	MM 850 nm	50/125 μm	0-8.1 dB	max. 300 m	3.0 dB/km	2,000 MHz*km
-LR/LC	SM 1310 nm	9/125 μm	0-7.8 dB	typ. 10 km	0.4 dB/km	3.5 ps/(nm*km)
-ER/LC	SM 1550 nm	9/125 μm	3-15 dB	10-40 km	0.25 dB/km	19 ps/(nm*km)
-ZR/LC	SM 1550 nm	9/125 μm	11-24 dB	40-80 km	0.25 dB/km	19 ps/(nm*km)

Table 12: F/O Port 10GBASE-SR/LR (XFP fiber optic 10 Gigabit Ethernet transceiver)

Product code M-SFP-BIDI...	Wave length TX	Wave length RX	Fiber	System attenuat ion	Example for F/O line length	Fiber data	BLP/ dispersion
Type A LX/LC EEC	SM	1310 nm	1550 nm	9/125 μm	0-11 dB	0-20 km	0.4 dB/km 3.5 ps/(nm×km)
Type B LX/LC EEC	SM	1550 nm	1310 nm	9/125 μm	0-11 dB	0-20 km	0.25 dB/km 19 ps/(nm×km)
Type A LH/LC EEC	LH	1490 nm	1590 nm	9/125 μm	5-24 dB	23-80 km	0.25 dB/km 19 ps/(nm×km)
Type B LH/LC EEC	LH	1590 nm	1490 nm	9/125 μm	5-24 dB	23-80 km	0.25 dB/km 19 ps/(nm×km)

Table 13: F/O port (bidirectional Gigabit Ethernet SFP Transceiver)

MM = Multimode, SM = Singlemode, LH = Singlemode Longhaul

■ Power consumption/power output

Name	Maximum power consumption	Maximum power output
MACH4002-48+4G	66.0 W	225.3 Btu (IT)/h
MACH4002-24G	66.0 W	225.3 Btu (IT)/h
MACH4002-24G+3X	74.0 W	252.6 Btu (IT)/h
MACH4002-48G	118.0 W	402.7 Btu (IT)/h
MACH4002-48G+3X	125.0 W	426.6 Btu (IT)/h
M4-POWER	0.0 W	0.0 Btu (IT)/h
M4-S-AC/DC 300W (230 V)	350.0 W	170.7 Btu (IT)/h
M4-S-AC/DC 300W (110 V)	370.0 W	238.9 Btu (IT)/h
M4-S-24VDC 300W	380.0 W	273.0 Btu (IT)/h
M4-S-48VDC 300W	380.0 W	273.0 Btu (IT)/h
M4-P-AC/DC 300W (230 V)	350.0 W	170.7 Btu (IT)/h
M4-P-AC/DC 300W (110 V)	370.0 W	238.9 Btu (IT)/h
M4-P-24VDC 300W	380.0 W	273.0 Btu (IT)/h
M4-P-48VDC 300W	380.0 W	273.0 Btu (IT)/h
M-SFP-LH+/LC	1.0 W	3.4 Btu (IT)/h
M-SFP-LH/LC	1.0 W	3.4 Btu (IT)/h
M-SFP-LX/LC	1.0 W	3.4 Btu (IT)/h
M-SFP-LX+/LC	1.0 W	3.4 Btu (IT)/h
M-SFP-MX/LC	1.0 W	3.4 Btu (IT)/h
M-SFP-SX/LC	1.0 W	3.4 Btu (IT)/h
M-FAST SFP-MM/LC	1.0 W	3.4 Btu (IT)/h
M-FAST SFP-SM/LC	1.0 W	3.4 Btu (IT)/h
M-FAST SFP-SM+/LC	1.0 W	3.4 Btu (IT)/h
M-FAST SFP-LH/LC	1.0 W	3.4 Btu (IT)/h
M-XFP-SR/LC	3.0 W	10.2 Btu (IT)/h
M-XFP-LR/LC	3.0 W	10.2 Btu (IT)/h
M-XFP-ER/LC	3.0 W	10.2 Btu (IT)/h
M-XFP-ZR/LC	3.0 W	10.2 Btu (IT)/h
M-SFP-BIDI Type A LX/LC EEC	1.0 W	3.4 Btu (IT)/h
M-SFP-BIDI Type B LX/LC EEC	1.0 W	3.4 Btu (IT)/h
M-SFP-BIDI Type A LH/LC EEC	1.0 W	3.4 Btu (IT)/h
M-SFP-BIDI Type B LH/LC EEC	1.0 W	3.4 Btu (IT)/h

Name	Maximum power consumption	Maximum power output
M4-8TP-RJ45	2.0 W	7.0 Btu (IT)/h
M4-8TP-RJ45 PoE	15.0 W	52.0 Btu (IT)/h
M4-FAST-SFP	15.0 W	52.0 Btu (IT)/h
M4-GIGA-SFP	3.0 W	10.2 Btu (IT)/h

■ Scope of delivery

Device	Scope of delivery
MACH4002-...	MACH4002-... device 1 terminal block for relay contact (4 contacts) Terminal cable 19" bracket, mounted, 2 height units Installation user manual CD/DVD
M4-POWER	M4-POWER power unit chassis Installation user manual 19" bracket, mounted, 2 height units
M4-S-... 300W	Plug-in power unit for M4-S-... 300 W basic switch device Installation user manual Cable for AC connection for AC supply Connector for each DC connection for DC supply
M4-P-... 300W	Plug-in power unit for M4-P-... 300W power unit chassis Installation user manual Cable for AC connection for AC supply Connector for each DC connection for DC supply Power supply cable for connecting power unit chassis to basic switch device

■ Order numbers/product description

Product description	Description	Order No.
Basic devices		
	Switch chassis 48+4G (up to 48 Fast Ethernet and 4 Gigabit Ethernet ports) incl. plug-in fan unit without power supply unit	
MACH4002-48+4G-L2P	- with Layer2 Professional software	943 859-101
MACH4002-48+4G-L3E	- with Layer3 Enhanced software	943 859-201
MACH4002-48+4G-L3P	- with Layer3 Professional software	943 859-301
	Switch chassis 24G (up to 24 Gigabit Ethernet ports) incl. plug-in fan unit without power supply unit	
MACH4002-24G-L2P	- with Layer2 Professional software	943 916-101
MACH4002-24G-L3E	- with Layer3 Enhanced software	943 916-201
MACH4002-24G-L3P	- with Layer3 Professional software	943 916-301
	Switch chassis 48G (up to 48 Gigabit Ethernet ports) incl. plug-in fan unit without power supply unit	
MACH4002-48G-L2P	- with Layer2 Professional software	943 911-101
MACH4002-48G-L3E	- with Layer3 Enhanced software	943 911-201
MACH4002-48G-L3P	- with Layer3 Professional software	943 911-301

Product description	Description	Order No.
MACH4002-24G+3X-L2P	Switch chassis 24G+3X (up to 24 Gigabit Ethernet ports and three 10-Gigabit Ethernet ports) incl. plug-in fan unit without power supply unit - with Layer2 Professional software	943 915-101
MACH4002-24G+3X-L3E	- with Layer3 Enhanced software	943 915-201
MACH4002-24G+3X-L3P	- with Layer3 Professional software	943 915-301
MACH4002-48G+3X-L2P	Switch chassis 48G+3X (up to 48 Gigabit Ethernet ports and three 10-Gigabit Ethernet ports) incl. plug-in fan unit without power supply unit - with Layer2 Professional software	943 878-101
MACH4002-48G+3X-L3E	- with Layer3 Enhanced software	943 878-201
MACH4002-48G+3X-L3P	- with Layer3 Professional software	943 878-301
M4-POWER	Power unit chassis (for 3 slide-in units)	943 874-001
Plug-in fan units		
M4-AIR	Plug-in fan for MACH4000 switch chassis without temperature sensor	943 869-001
M4-AIR-L	Plug-in fan for MACH4000 switch chassis with reduced fan speed for use in ambient temperatures up to a maximum of +40 °C.	942 005-001
Plug-in power units		
M4-S-AC/DC 300W	Plug-in AC power unit (300 W) for basic switch device	943 870-001
M4-S-24VDC 300W	Plug-in 24 V DC power unit, single-current, for switch chassis (2 connections coupled via diodes, one DC/DC converter)	943 871-001
M4-S-48VDC 300W	Plug-in 48 V DC power unit, single-current, for switch chassis (2 connections coupled via diodes, one DC/DC converter)	943 872-001
M4-P-AC/DC 300W	Plug-in AC power unit (300 W) for power unit chassis	943 875-001
M4-P-24VDC 300W	Plug-in 24 V DC power unit, single-current, for power unit chassis (2 connections coupled via diodes, one DC/DC converter)	943 876-001
M4-P-48VDC 300W	Plug-in 48 V DC power unit, single-current, for power unit chassis (2 connections coupled via diodes, one DC/DC converter)	943 877-001
Media modules		
M4-8TP-RJ45	Plug-in module 8 TP RJ45 (10/100, 10/100/1000)	943 863-001
M4-FAST 8TP-RJ45 PoE	Plug-in module 8 TP RJ45 PoE (Power over ETHERNET in compliance with IEEE 802.3af, 10/100)	943 873-001
M4-FAST 8-SFP	Plug-in module 8 SFP (100 HDX/FDX)	943 864-001
M4-GIGA 8-SFP	Plug-in module 8 SFP (100 FDX or 1000 FDX, depending on SFP)	943 879-001

■ Accessories

Note: Please note that products recommended as accessories may have characteristics that do not fully correspond to those of the corresponding product. This may limit their possible usage range in the overall system.

Name	Operating temperature (chassis)	Order number
AutoConfiguration Adapter ACA 21-USB		943 271-001
Terminal cable		943 301-001
M4-POWER CABLE (connection cable red. power supply)		943 922-001
M4-RACKMOUNT (bracket for mounting the MACH4000 in the 19" cabinet)		943 951-101
M4-RACKMOUNT-50 (19" bracket for mounting the MACH4000 in the 19" cabinet, 50 mm lower than with M4_RACKMOUNT)		943 951-001
4-pin terminal block (50 pcs.)		943 845-004
Industrial HiVision Network Management software, operator edition		943 156-xxx
OPC Server software HiOPC		943 055-001
10-Gigabit Ethernet XFP transceiver		
M - XFP - SR / LC	0 °C ... +60 °C	943 917-001
M - XFP - LR / LC	0 °C ... +60 °C	943 919-001
M - XFP - ER / LC	0 °C ... +60 °C	943 920-001
M - XFP - ZR / LC	0 °C ... +60 °C	943 921-001
Gigabit Ethernet SFP transceiver		
M - SFP - SX / LC	0 °C ... +60 °C	943 014-001
M - SFP - MX / LC	0 °C ... +60 °C	942 035-001
M - SFP - LX / LC	0 °C ... +60 °C	943 015-001
M - SFP - LX+ / LC	0 °C ... +60 °C	942 023-001
M - SFP - LH / LC	0 °C ... +60 °C	943 042-001
M - SFP - LH / LC EEC	-40 °C ... +70 °C	943 898-001
Fast Ethernet SFP transceiver		
M-FAST SFP-MM/LC	0 °C ... +60 °C	943 865-001
M-FAST SFP-SM/LC	0 °C ... +60 °C	943 866-001
M-FAST SFP-SM+/LC	0 °C ... +60 °C	943 867-001
M-FAST SFP-LH/LC	0 °C ... +60 °C	943 868-001
Bidirectional Gigabit Ethernet SFP transceiver		
M-SFP-BIDI Type A LX/LC EEC	0 °C ... +60 °C	943 974-001
M-SFP-BIDI Type B LX/LC EEC	0 °C ... +60 °C	943 974-002
M-SFP-BIDI Type A LH/LC EEC	0 °C ... +60 °C	943 975-001
M-SFP-BIDI Type B LH/LC EEC	0 °C ... +60 °C	943 975-002
M-SFP-BIDI Bundle LX/LC EEC (Type A + B)	0 °C ... +60 °C	943 974-101
M-SFP-BIDI Bundle LH/LC EEC (Type A + B)	0 °C ... +60 °C	943 975-101

■ Underlying norms and standards

Standard	
EN 61000-6-2	Electromagnetic compatibility (EMC) – Part 6-2: Generic standards – Immunity for industrial environments
EN 55022	Information technology equipment – Radio disturbance characteristics – Limits and methods of measurement
EN 60950-1	Information technology equipment – Safety – Part 1: General requirements
EN 61131-2	Programmable controllers – Part 2: Equipment requirements and tests
EN 50121-4	Railway applications - EMC - emitted interference and interference immunity for signal and telecommunication systems
FCC 47 CFR Part 15	Code of Federal Regulations
Germanischer Lloyd	Rules for Classification and Construction VI-7-2 – GL
UL 508	Safety for Industrial Control Equipment
UL 60950-1	Safety for Information Technology Equipment

Table 14: List of norms and standards

The device has a certification based on a specific standard only if the certification indicator appears on the housing.
 However, with the exception of Germanischer Lloyd, ship certifications are only included in the product information under www.hirschmann.com.

A Further Support

■ Technical Questions

For technical questions, please contact any Hirschmann dealer in your area or Hirschmann directly.

You will find the addresses of our partners on the Internet at

<http://www.hirschmann.com>

Contact our support at

<https://hirschmann-support.belden.eu.com>

You can contact us

in the EMEA region at

▶ Tel.: +49 (0)1805 14-1538

▶ E-mail: hac.support@belden.com

in the America region at

▶ Tel.: +1 (717) 217-2270

▶ E-mail: inet-support.us@belden.com

in the Asia-Pacific region at

▶ Tel.: +65 6854 9860

▶ E-mail: inet-ap@belden.com

■ Hirschmann Competence Center

The Hirschmann Competence Center is ahead of its competitors:

▶ Consulting incorporates comprehensive technical advice, from system evaluation through network planning to project planning.

▶ Training offers you an introduction to the basics, product briefing and user training with certification.

The current technology and product training courses can be found at

<http://www.hicomcenter.com>

▶ Support ranges from the first installation through the standby service to maintenance concepts.

With the Hirschmann Competence Center, you have decided against making any compromises. Our client-customized package leaves you free to choose the service components you want to use.

Internet:

<http://www.hicomcenter.com>



HIRSCHMANN

A **BELDEN** BRAND